

What is Carbon Black?





Contents

1 Introduction	4
1.1 About Orion Engineered Carbons	4
1.2 What is Carbon Black	7
2 Manufacturing Process	10
2.1 Raw Materials	12
2.2 Thermal-Oxidative Processes	14
2.2.1 Furnace Black Process	14
2.2.2 Degussa Gas Black Process	18
2.2.3 Lamp Black Process	19
2.2.4 Channel Black Process (historical)	20
2.3 Thermal Decomposition Processes	21
2.3.1 Thermal Black Process	21
2.3.2 Acetylene Black Process	22
2.4 Carbon Black Dispersions, Compounds, Plastic and Rubber Masterbatches	23
3 Properties of Carbon Black	24
3.1 General Physical and Chemical Properties	25
3.2 Definition of Carbon Black	27
3.3 Test Methods, Chemical and Physical Data	28
3.3.1 Determination of Surface Area	32
3.3.2 Determination of Structure	33
3.3.3 Colorimetric Characterization	33
3.3.4 Chemical and Physical Measurements	34
3.3.5 Physical Appearance and Handling Properties	34
3.4 Specifications and Quality Assurance	35
3.5 Characteristic Data of various Production Processes	36
4 Handling	38
5 Product Safety	40
5.1 Toxicology	40
5.2 Safety-Related Properties	41
6 Applications	42
6.1 Rubber Carbon Blacks	42
6.2 Specialty Carbon Blacks	44

1 Introduction

1.1 About Orion Engineered Carbons

Who We Are?

Orion Engineered Carbons (OEC) is one of the world's leading suppliers of Carbon Black. We offer standard and high-performance products for coatings, printing inks, polymers, rubber and other applications. Our high-quality Gas Blacks, Furnace Blacks and Specialty Carbon Blacks tint, colorize and enhance the performance of plastics, paints and coatings, inks and toners, adhesives and sealants, tires, and manufactured rubber goods such as automotive belts and hoses.

With 1,425 employees worldwide, Orion Engineered Carbons runs 14 global production sites and 4 Applied Technology Centers, focusing on quality supply and collaborative partnerships with customers. Common shares of Orion Engineered Carbons are traded on the New York Stock Exchange under the symbol OEC.



Our Vision

"We are the premium supplier of Carbon Black.

We generate long-term benefits for stakeholders while remaining committed to responsible business practices with a focus on team culture, reliability and sustainability."

Strategic Elements of our Mission

Operational Excellence	Market and Technology-Driven Product Portfolio	Reliable Partner	Grow with Customers
Key Figures			
Sales 2020	\$ 1.13 billion		
Number of Production Sites	14		
Number of Applied Technology Centers	4		
Employees	about 1,425		
Active in	over 80 countries		
Production Capacity p.a.	1.2 million t		

Locations

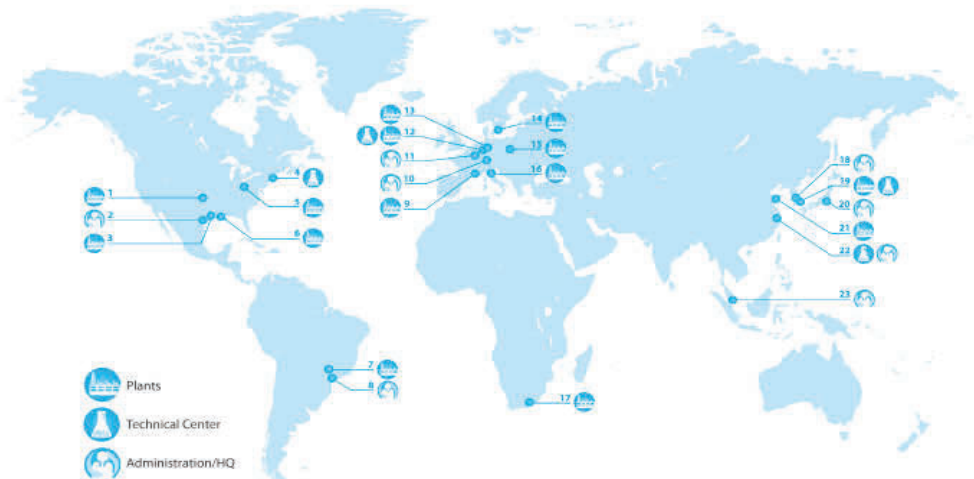

1) USA, Borger

Orion Engineered Carbons LLC
9440 FM 1559, Hwy 136
Borger, TX 79007, USA

2) USA, Houston (Principal Executive Office + Regional Headquarters)

Orion Engineered Carbons LLC
4501 Magnolia Cove Drive
Suite 106
Houston, TX 77345, USA

3) USA, Orange

Orion Engineered Carbons LLC
1513 Echo Road
Orange, TX 77632, USA

4) USA, Carlstadt

Orion Engineered Carbons LLC
631 Central Avenue
Carlstadt, NJ 07072, USA

5) USA, Belpre

Orion Engineered Carbons LLC
11135 State Route 7
Belpre, OH 45714-9496, USA

6) USA, Ivanhoe

Orion Engineered Carbons LLC
7095 Highway 83
Franklin, LA 70538, USA

7) Brazil, Paulínia

Orion Engineered Carbons Ltda.
Av. Antonio Fadin, 1300
Paulínia, SP, CEP 13147-030, Brazil

8) Brazil, São Paulo

Orion Engineered Carbons Ltda.
R. Maestro Cardin, 1293
São Paulo, SP, 01323-001, Brazil

9) France, Berre l'Etang

Orion Engineered Carbons France sas
RD21F CS80098
13131 Berre l'Etang cedex

10) Germany, Frankfurt (Global Operational and Administrative Headquarters)

Orion Engineered Carbons GmbH
Hahnstraße 49
60528 Frankfurt a.M., Germany

11) Luxembourg (Global Corporate Headquarters)

Orion Engineered Carbons S.A.
6 Route de Trèves
2633 Senningerberg, Luxembourg

12) Germany, Cologne (Plant and Technical Center)

Orion Engineered Carbons GmbH
Harry-Kloepfer-Straße 1
50997 Cologne, Germany

13) Germany, Dortmund

Deutsche Gasrußwerke GmbH & Co KG
Weidenstraße 70-72
44147 Dortmund, Germany

14) Sweden, Malmö

Norcarb Engineered Carbons AB
Kusthamnsgatan 1
211 24 Malmö, Sweden

15) Poland, Jaslo

Orion Engineered Carbons Sp. z o.o.
83 3-go Maja Street
38-200 Jaslo, Poland

16) Italy, Ravenna

Orion Engineered Carbons S.r.l.
Via Baiona 170
48123 Ravenna, Italy

17) South Africa, Gqeberha (Port Elizabeth)

Orion Engineered Carbons PTY (LTD)
John Tallant Road
6000 Port Elizabeth, South Africa

18) Korea, Seoul

Orion Engineered Carbons Co., Ltd.
Room 1101, 55, Magokdong-ro, Gangseo-gu,
Seoul, South Korea

19) Korea, Yeosu (Plant and Technical Center)

Orion Engineered Carbons Korea Co., Ltd.
350, Wollae-dong
Yeosu-si, Jeollanam-do, 555-260,
South Korea

20) Japan, Tokyo

Orion Engineered Carbons KK
Holland Hills Mori Tower 16F
5-11-2, Toranomom, Minato-Ku,
Tokyo 105-0001, Japan

21) China, Qingdao

Orion Engineered Carbons Qingdao Co., Ltd.
47 North Fuzhou Road
Jiaozhou 266300, Shandong, China

22) China, Shanghai (Regional Headquarters)

Orion Engineered Carbons Trading
(Shanghai) Co., Ltd.
BM Intercontinental Business Centre,
Room 3701-3702
100 Yutong Road
200070 Shanghai, China

China, Shanghai (Technical Center)

Orion Engineered Carbons Material
Technology (Shanghai) Co., Ltd.
Room 501-503
Building 1, Shanghai Juke Biotech Park
No. 466 Yindu Road, Xuhui District
200231 Shanghai, China

23) Singapore, Singapore

Orion Engineered Carbons Pte Ltd
31 Bukit Batok Crescent #04-01
The Splendour Singapore 658070

1 Introduction

History of Orion Engineered Carbons

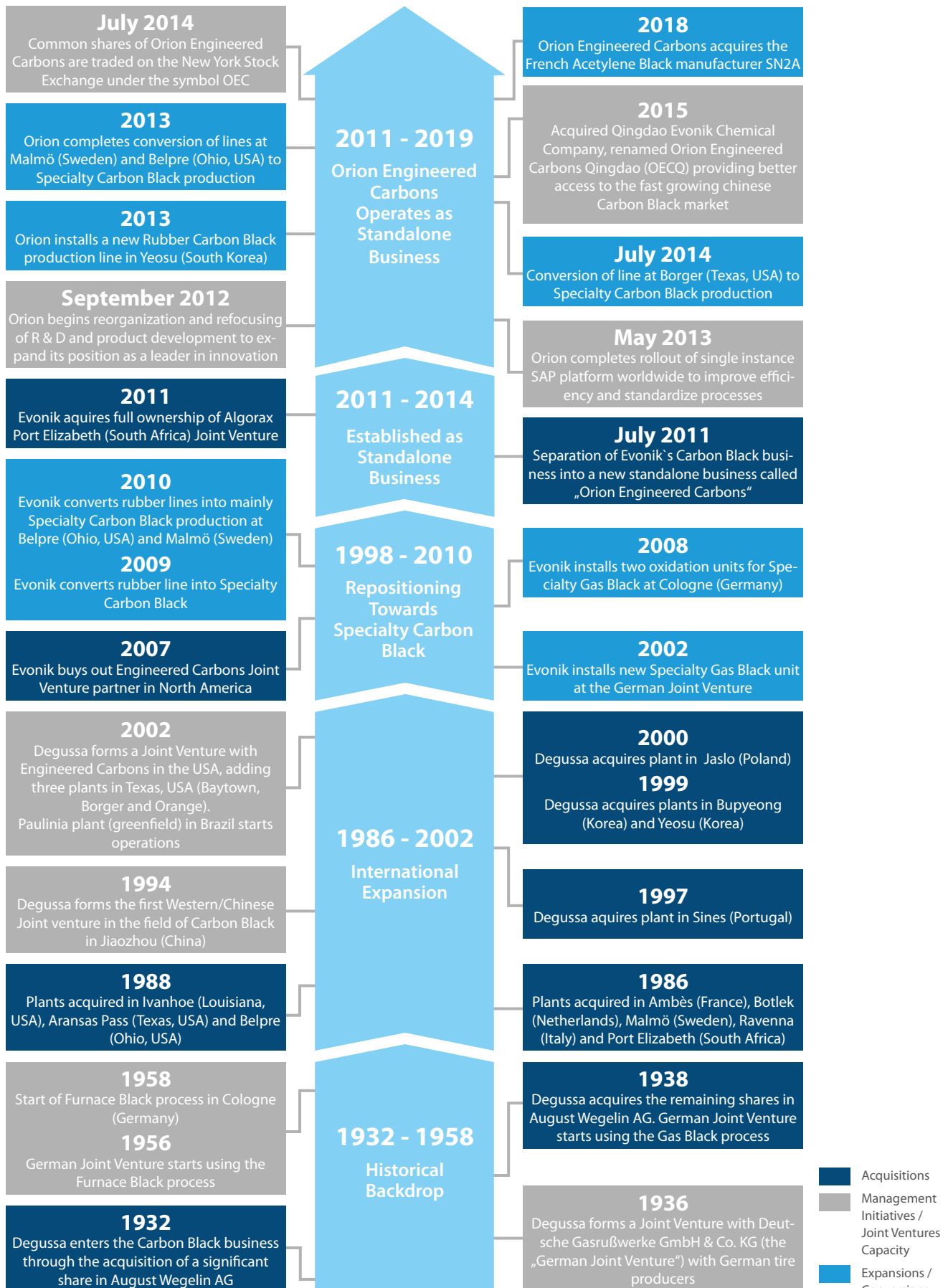

1.2 What is Carbon Black?

Carbon Black is a commercial form of solid carbon that is manufactured in highly controlled processes to produce specifically engineered aggregates of carbon particles that vary in particle size, aggregate size, shape, porosity and surface chemistry. Carbon Black typically contains more than 95 % pure carbon with minimal quantities of oxygen, hydrogen and nitrogen. In the manufacturing process, Carbon Black particles are formed that range from 10 nm to approximately 500 nm in size. These fuse into chain-like aggregates, which define the structure of individual Carbon Black grades.

Carbon Black is used in a diverse group of materials in order to enhance their physical, electrical and optical properties. Its largest volume use is as a reinforcement and performance additive in rubber products. In rubber compounding, natural and synthetic elastomers are blended with Carbon Black, elemental sulfur, processing oils and various organic processing chemicals, and then heated to produce a wide range of vulcanized rubber products. In these applications, Carbon Black provides reinforcement and improves resilience, tear-strength, conductivity and other physical properties. Carbon Black is the most widely used and cost-effective rubber reinforcing agent (typically called Rubber Carbon Black) in tire components (such as treads, sidewalls and inner liners), in mechanical rubber goods ("MRG"), including industrial rubber goods, membrane roofing, automotive rubber parts (such as sealing systems, hoses and anti-vibration parts) and in general rubber goods (such as hoses, belts, gaskets and seals).

Besides rubber reinforcement, Carbon Black is used as black pigment and as an additive to enhance material performance, including conductivity, viscosity, static charge control and UV protection. This type of Carbon Black (typically called Specialty Carbon Black) is used in a variety of applications in the coatings, polymers and printing industries, as well as in various other special applications.

In the coatings industry, treated fine particle Carbon Black is the key to deep jet black paints. The automotive industry requires the highest jetness of black pigments and a bluish undertones.



Small particle size Carbon Blacks fulfill these requirements. Coarser Carbon Blacks, which offer a more brownish undertone, are commonly used for tinting and are indispensable for obtaining a desired gray shade or color hue.

In the polymer industry, fine particle Carbon Black is used to obtain a deep jet black color. A major attribute of Carbon Black is its ability to absorb detrimental UV light and convert it into heat, thereby making polymers, such as polypropylene and polyethylene, more resistant to degradation by UV radiation from sunlight. Specialty Carbon Black is also used in polymer insulation for wires and cables. Specialty Carbon Black also improves the insulation properties of polystyrene, which is widely used in construction.

In the printing industry, Carbon Black is not only used as pigment but also to achieve the required viscosity for optimum print quality. Post-treating Carbon Black permits effective use of binding agents in ink for optimum system properties. New Specialty Carbon Blacks are being developed on an ongoing basis and contribute to the pace of innovation in non-impact printing.

1 Introduction

With a yearly production volume exceeding ten million metric tons, the most important Carbon Black manufacturing process is the Furnace Black method. More than 98 % of the world's annual Carbon Black production is manufactured through this process. Nevertheless, other manufacturing methods are also used in the commercial production of Carbon Black, e.g., for fabrication of Gas Blacks, Lamp Blacks, Thermal Blacks and Acetylene Blacks.

The variety of Carbon Blacks, its production methods and possible applications show that "soot" has come a long way. Much has been published about the subject in technical journals, textbooks, reference works and product brochures. This brochure will reveal the many interesting facets of Carbon Black - a product that is both simple and sophisticated. Indeed, many of the things we take for granted in our everyday lives would not be possible without Carbon Black.

History of Carbon Black

Ancient civilizations in China and Egypt mixed soot into resins, vegetable oils or tar to create colors and inks. Allowing a flame, usually from an oil lamp, to come in contact with a cooled surface causes soot to accumulate on the cooled surface. The soot could then be scraped off and collected as a powder. This process, referred to as the impingement process, that involves using the flame from an oil lamp was a precursor to today's Lamp Black process. However it is also the basis of the Channel and Gas Black processes, which utilize gas flames impinging on cool cast iron channels or rotating cooled cylinders.

Later on, both the Greeks and the Romans had a predilection for black to decorate walls, resulting in a great need for soot (Figure 1). In what has become a standard work of antiquity, "De Architectura," Roman master builder Vitruvius describes in painstaking detail a technical method in which resin is fired in a brick-lined furnace and Carbon Black is precipitated in large quantities in a special chamber (Figure 2).

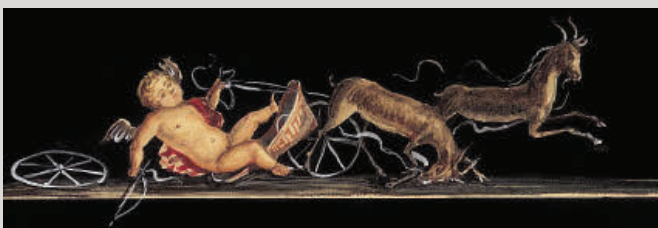
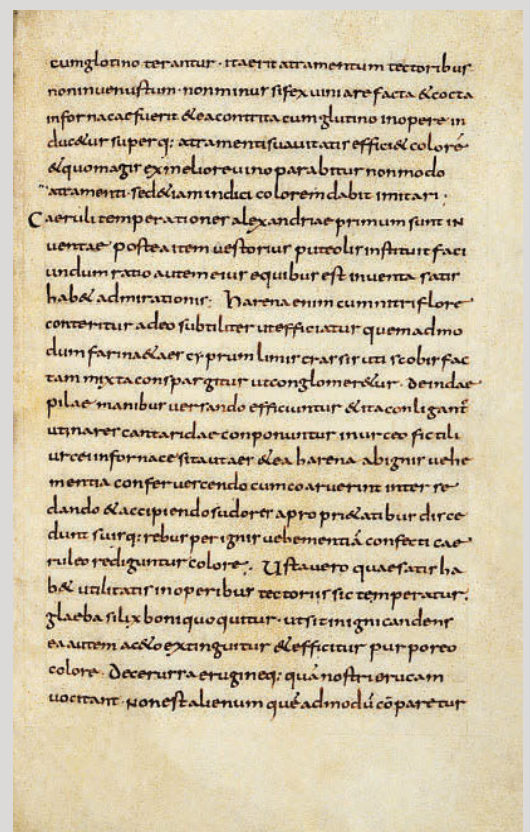

Figure 1:
Roman Fresco, Pompeii



2a)

Area	Application
Rubber	Reinforcing filler in tires and mechanical rubber components, conductivity
Printing Inks	Pigmentation, rheology, tinting
Coatings	Black and grey pigmentation, tinting
Plastics	Black and grey pigmentation, tinting, UV protection, conductivity, conductor coating
Fibers	Pigmentation
Paper	Black and grey pigmentation, conductivity, decorative and photo-protective papers
Construction	Cement and concrete pigmentation, conductivity
Power	Carbon brushes, electrodes, battery cells
Metal Reduction Compounds	Metal smelting, friction compound
Metal Carbide	Reduction compound, carbon source
Fireproofing	Reduction of mineral porosity
Insulation	Graphite furnaces, polystyrene and PU foam

Table 1:
Major Carbon Black applications

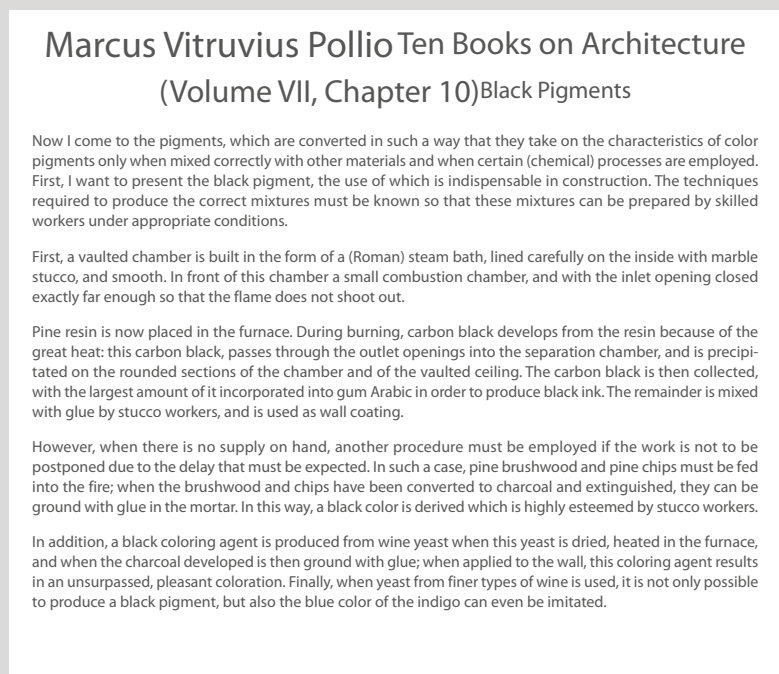
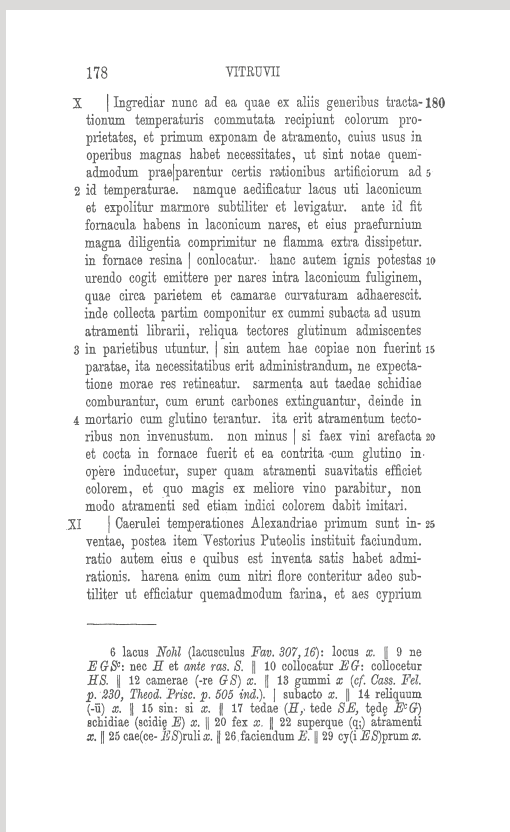

2c)

Figure 2:
Description of Carbon Black production process in "De Architectura" by Vitruvius
a) Medieval manuscript
b) Latin text
c) English translation

2 Manufacturing Process



In answering the question “What is Carbon Black?” the impact of the production method on the properties of the end product suggests that we should first focus on the available methods before describing the various properties of the resulting products.

That is because the properties are defined at the earliest stage of the manufacturing process, regardless of whether the Carbon Black is intended for use in the rubber and plastics industry, the printing industry or for conductivity applications.

History of Carbon Black

Atrāmentum, i, n. Dinten / schwarze Farb. it. Nien-Ruß. Cic. Atramentum impressorium, Drucker-Farb. Sutorium atramentum, Kupfer-Wasser / Schuh-Schwärze. Plin. Atramento tutorio absolutus est, er ist ins schwarze Register kommen / ans schwarze Bret geschlagen worden. Cic. Atramentum tinctorium, Lüncher-Schwärze. Vitruv.

Figure 3:
Excerpt from CORNUPIAE,
a Latin-German dictionary published in 1780

Pine resin proved an ideal raw material for Carbon Black used in printing inks, and Germany's Black Forest region soon became the epicenter of a thriving industry. Special settling chambers made it possible to conveniently produce large quantities of Carbon Black (Figure 5).

The process has essentially remained the same since Vitruvius first described it. Centuries later, the invention of the letter press would create an even greater demand for Carbon Black, as writing inks, having water like consistencies, had to be replaced with more viscous printing inks (Figure 3). As a result, manufacturing Carbon Black became a trade, with many entrepreneurs setting up shops with a furnace to produce Lamp Black. Figure 4 shows a furnace such as those in use during the 18th century.

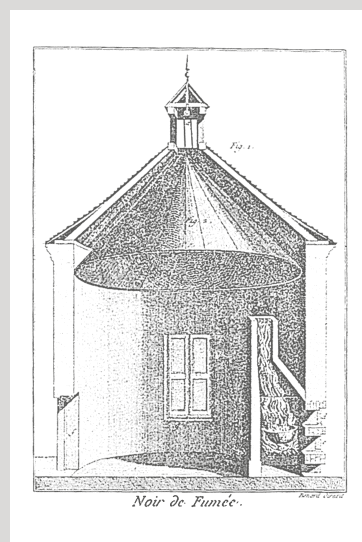

Figure 4:
Ancient Lamp Black process
as described in Diderot's
“Encyclopédie” (Paris 1770/80)

The basic raw material for the production of Carbon Black consists of hydrocarbons that are split into their constituent elements, carbon and hydrogen, by either a thermal or thermal-oxidative (partial combustion) process. Economically, the thermal-oxidative decomposition has become the predominant method, with the hydrocarbons taking on a double role since they serve both as a source of heat and of carbon.

A burning candle easily demonstrates how this works. The outermost zone of the flame is where some of the hydrocarbons can burn as there is ample supply of oxygen nearby to feed the combustion process.

This in turn generates the heat required to melt and vaporize the wax. The dark area surrounding the burning wick is in fact wax being transformed into vapor. In the inner, luminous zone, there is a deficiency of oxygen and it is in this region that soot forms, visible as the thin black trail that floats up from the tip of the flame. It can be collected by bringing the reacting gases into contact with a cooled surface.

Every Carbon Black production method is based on the two fundamental elements of heat and decomposition; how these stages are arranged is what defines the difference between the production processes.

Chemical Process	Manufacturing Method	Main Raw Materials
Thermal-Oxidative Decomposition	Furnace Black process Degussa Gas Black process Lamp Black process	Aromatic oils on coal tar basis or mineral oil, natural gas Coal tar distillates Aromatic oils on coal tar basis or mineral oil
Thermal Decomposition	Thermal Black process Acetylene Black process	Natural gas (or mineral oils) Acetylene

Table 2:
Production methods and raw materials

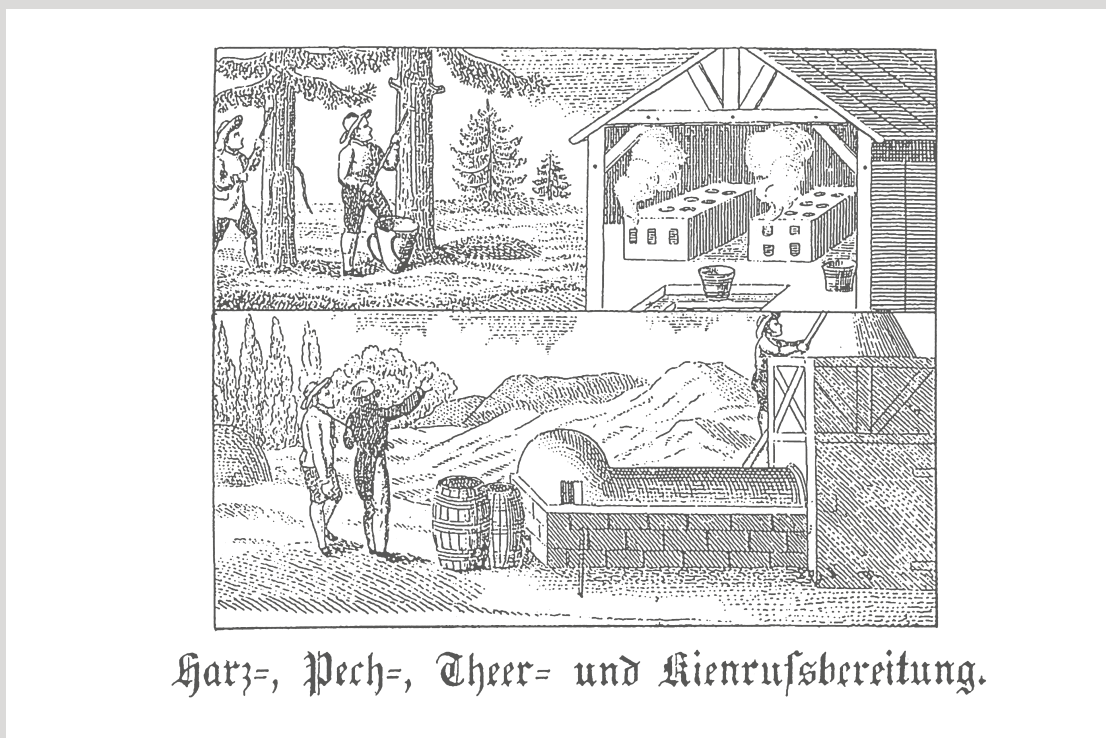

Figure 5:
Processing pine resin to create pitch, tar and Carbon Black

2 Manufacturing Process

2.1 Raw Materials

The preferred feedstock for most Carbon Black production processes, especially the Furnace Black process, is heavy oil with a high content of aromatic hydrocarbons. The aromatic form of carbon gives the greatest carbon-to-hydrogen ratio, thus maximizing the available carbon, and is the most efficient in terms of Carbon Black yields. Theoretically, the greater the aromaticity the more efficient the process is. Unfortunately, as the number of combined rings increases the substances move from viscous liquids to solid pitches.

Therefore, in reality the most suitable oils are those in which the majority of the carbon is in the form of substances comprising three- or four-membered rings.

Distillates from coal tar (carbo-chemical oils) or residual oils that are created by catalytic cracking of mineral oil fractions and olefines manufactured by the thermal cracking of naphta or gasoil (petro-chemical oil) also qualify as a source of raw material.

History of Carbon Black

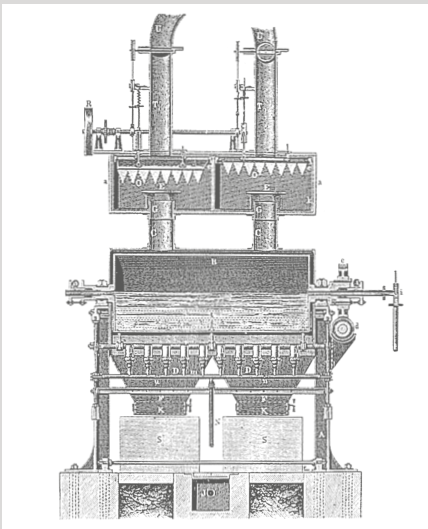

Figure 6:
Gas Black manufacturing apparatus as depicted
in German patent application DRP 29261

The industrial revolution eventually took Carbon Black production to higher volumes by making coal tar available in large quantities. The Lamp Black process was also perfected to include a labyrinth collection chamber. Even though yield was substantially increased, Carbon Black was only incompletely precipitated.

Lamp Black chambers based on this design remained in operation until the middle of the 19th century before they were gradually replaced by more environmentally-friendly filter systems.

Towards the end of the 19th century, the Carbon Black industry on the other side of the Atlantic had developed a process with natural gas as the feedstock. The main reason was the ample supply of this inexpensive resource and the realization that the firing process produced a special type of Carbon Black. The firing plants were designed in such a way that

they could easily be moved to another site once a well was depleted. This so-called Channel Black quickly experienced growing demand when its reinforcing properties became clear to the rubber industry – properties which Lamp Black did not offer. The finer particles obtained from Channel Black made it possible to increase tire longevity to several tens of thousands of miles. In retrospect, the automobile industry owes much of its rapid growth to the discovery and refinement of Channel Black production.

In Europe, the scarcity of natural gas led to the development of an analogous method based on coal tar. By 1935, Degussa's Gas Black system (Figure 6) proved a viable alternative to the American Channel Black method. Until after World War II the whole tire industry was dominated by the Channel Black method in the US and the Gas Black method in Germany.

The yield of Carbon Black depends on the aromaticity of the feedstock. It was commonly measured by BMCI (Bureau of Mines Correlation Index) value. However, BMCI is only applicable to feedstocks derived from petroleum. In the case of carbochemical-oils the BMCI may not reflect the true aromaticity of the product. For this reason the carbon-to-hydrogen ratio is favored for carbochemical products. However, as this measurement is also superior to BMCI, even for petrochemical products, the carbon-to-hydrogen ratio and the carbon content are becoming the preferred criteria for all Carbon Black feedstocks.

Additional quality requirements involve impurities from foreign matter. Alkaline metals, for instance, are important because they have a direct effect on a specific Carbon Black property. The sulfur content of the oil can also play a significant role in production operations since in many countries production sites have to meet strict environmental standards. Sulfur emissions from combustion processes are restricted by law. Furthermore, Carbon Blacks with high sulfur contents might be prohibitive for certain applications. As we look at the various production methods, we will also address the different raw materials that can be used to produce Carbon Black.

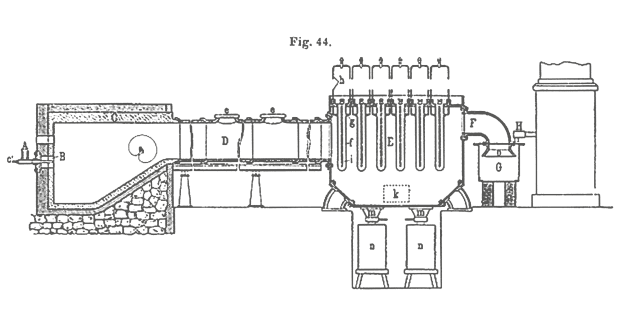

a)

As early as the 19th century (Figure 7 a, b), and more intensively from the 1920s onwards, attempts were made to produce Carbon Black in a completely closed system with mineral oil as the feedstock. Although the gas furnace process played a role in the US, the oil furnace method – first commercialized in 1943 – eventually became the method of choice.

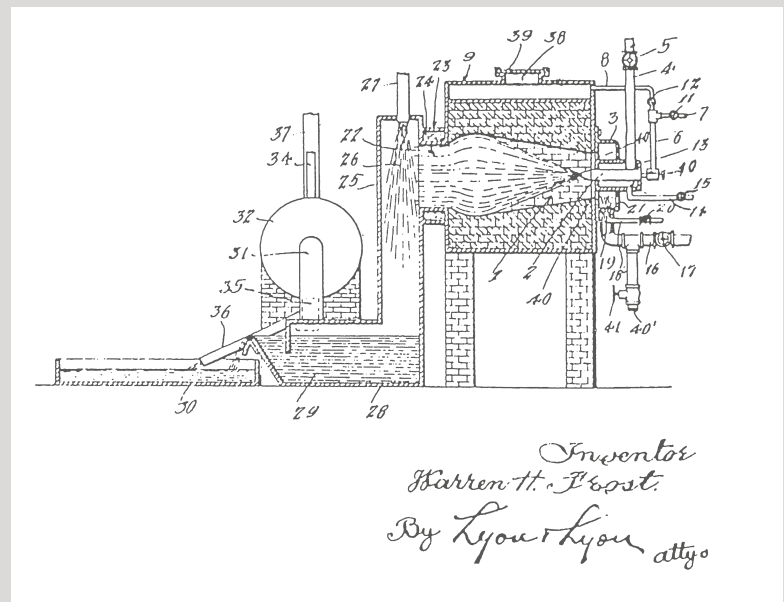

b)

Figure 7:

a) Furnace Black reactor, German patent DRP 50605 of 1899

b) Furnace Black reactor, US patent 1,438,032 of 1922

2 Manufacturing Process

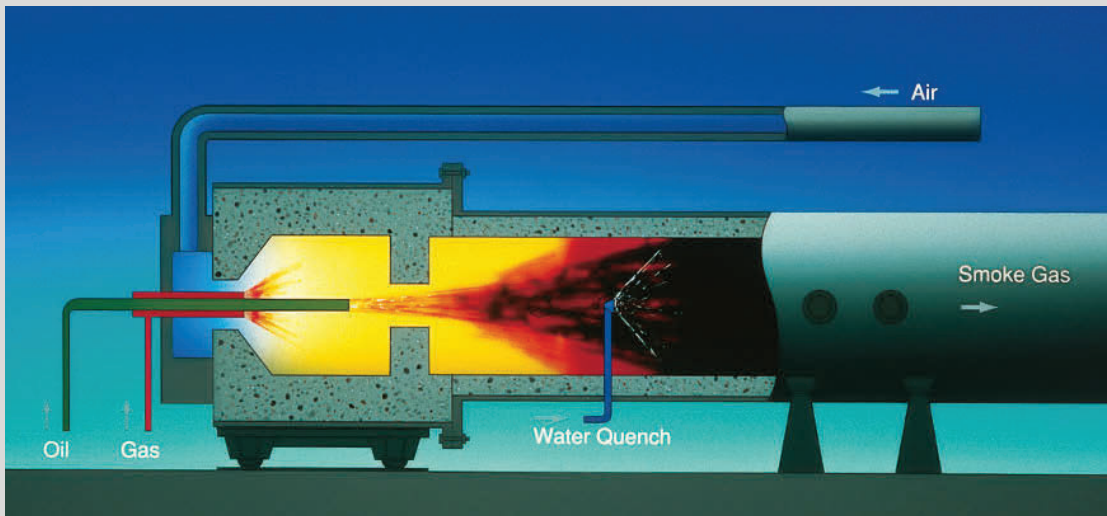

Figure 8:
Scheme of a Furnace Black
reactor

2.2 Thermal-Oxidative Processes

2.2.1 Furnace Black Process

The most recently developed process, the Furnace Black method (Figure 8) has become the most common in large scale Carbon Black manufacturing. The Furnace Black method is continuous and uses liquid and gaseous hydrocarbons as feedstock and as heat source respectively. When natural gas is available, the liquid feedstock is sprayed into a heat source that is generated by the combustion of the natural gas and pre-heated air. Because it occurs at a very high temperature, the reaction is confined to a refractory-lined furnace, hence the name (Figure 10). After the Carbon Black is formed, the process mixture is quenched by injecting water. This also prevents any unwanted secondary reactions. The Carbon Black loaded gas then passes through a heat exchanger for further cooling, while simultaneously heating up the required process air. A bag filter system separates the Carbon Black particles from the gas stream. The gases produced by the reaction are combustible and, in most cases, are fed into an afterburning stage where the heat is used to dry the Carbon Black, or are burnt in a boiler to generate steam. The Carbon Black collected by the filter has a very low bulk density and, depending on the application, is usually pelletized or further densified to facilitate onward handling.

The wet-pelletizing process uses water and a binding agent in a specially designed wet pellet or “pin” mixer, which transforms the Carbon Black into spherical pellets. The Carbon Black pellets are then dried in rotary dryers. The binding agent ensures that the product is resistant to attrition and is easy to process and transport (Figure 9).

The incorporation of these pellets in a polymer matrix requires substantial shear forces, mostly applied by internal mixers in the rubber industry.

Specialty Carbon Blacks that are produced by the Furnace Black process are either loosely densified and packaged as powder Carbon Blacks or are transformed to easily dispersible pellets by application of the dry-pelletizing process (Figure 11).

Oil-pelletized Carbon Blacks, used primarily in the pigment industry, are an additional variant that utilizes mineral oils in the pelletization process. Because of the light oil coating, these Carbon Blacks are characterized by even easier dispersion and virtually dust-free handling.

The Furnace Black method offers environmental and work safety benefits. The fully closed installation keeps the emission of process gases and dust to a minimum.

Besides its environmental, economic and technical advantages it also allows greater flexibility because it is capable of manufacturing more different grades of Carbon Black than any other process currently being used. All raw materials are precisely specified in terms of quality, type and quantity. This makes it possible to produce a broad range of Carbon Blacks, which are suitable for use in various applications without fundamentally changing the process for each product variant. For instance, particle size or specific surface area can easily be defined at the outset by setting the appropriate process parameters. The Furnace Black process

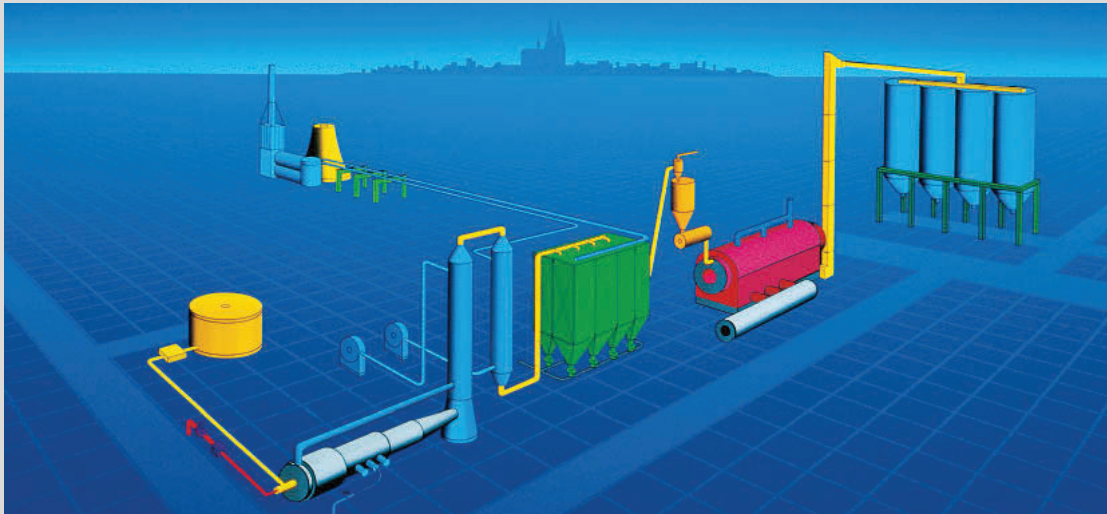

Figure 9:
Furnace Black production installation

also permits the manufacturer to control particle aggregation, the so-called Carbon Black structure, by adding small quantities of an alkaline metal salt.

The Furnace Black method creates Carbon Black with primary particle sizes ranging from 10 to 80 nm. The primary particle size is mentioned to indicate the application properties of a given product. Free primary particles do not exist as they are strongly fused together and form so-called aggregates. Examples of Furnace Blacks with different particle sizes and structures are illustrated by the electron microscopic images that are presented on the next page (Figure 12).

However, it has not yet been possible to replicate the unique properties of Gas and Lamp Blacks with the Furnace Black method.



Figure 10:
Furnace Black reactor (section)



Furnace Black production installation:
Carbon Black created from gas and oil in a reactor with pre-heated combustion air is passed through a filtering stage and separated from other emissions. The product is then wet-pelletized, dried in a rotary drier and fed into a storage silo. The gaseous emissions and heat resulting from the process are used to generate steam in a boiler.

2 Manufacturing Process

Figure 11:



1) Powder Carbon Black



2) Dry-Pelletized Carbon Black

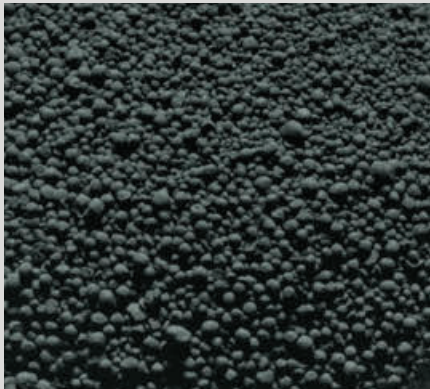

3) Wet-Pelletized Carbon Black



Figure 12: Furnace Blacks of varying particle size and structure.

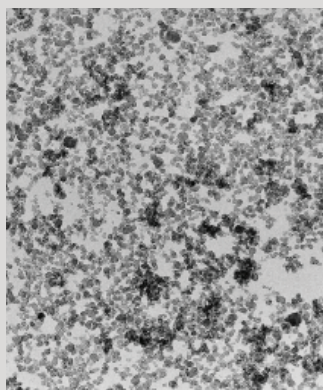

1) Furnace Black, fine primary particle size

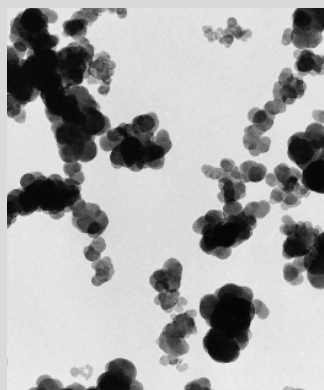

2) Furnace Black, coarse primary particle size

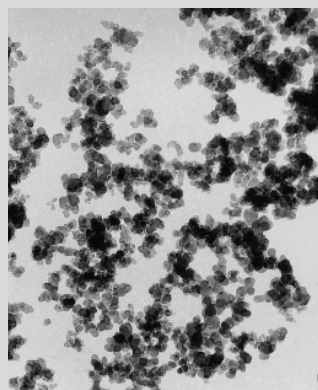

3) High-structure Furnace Black

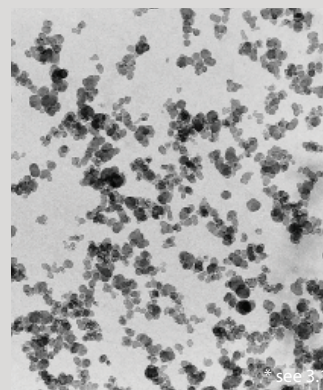

4) Low-structure Furnace Black



Figure 13:
OEC Carbon Black plant
in Cologne (Kalscheuren)

2 Manufacturing Process

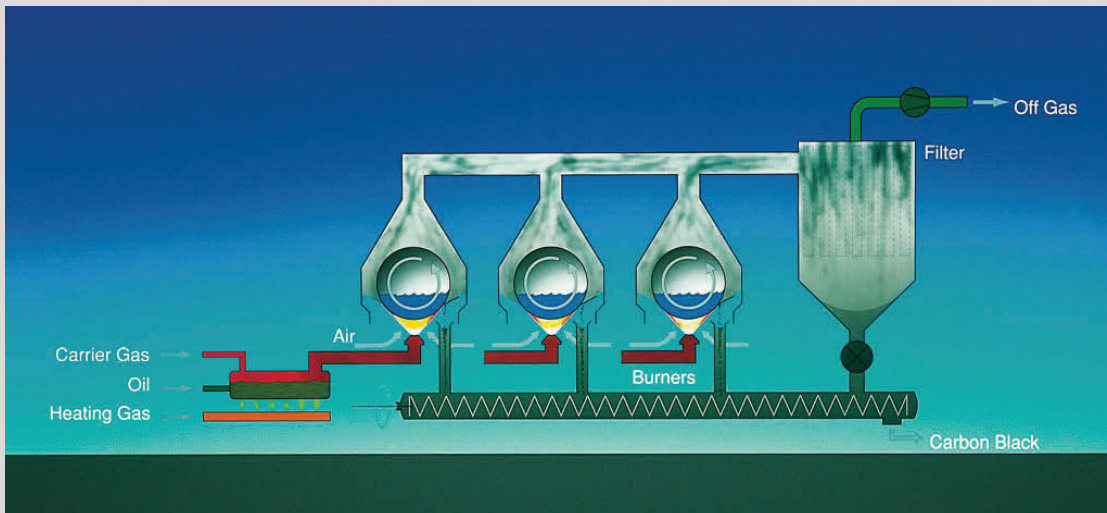

Figure 14:
Scheme of Gas Black
production process

2.2.2 Degussa Gas Black Process

The Gas Black method developed by Degussa in the mid-1930s is closely related to the Channel Black process developed in the US based on natural gas as the feedstock. As this resource was much scarcer in Europe, the Degussa Gas Black method was developed to use coal tar distillates as raw material instead.

In contrast to the Channel Black process, which poses a substantial burden on the environment, gas black plants are at the cutting edge of environmental technology. The facilities are continuously vacuum-cleaned and the Carbon Black is collected in sealed filter systems that exceed official emission standards by a significant margin.

The Gas Black process uses oil instead of natural gas as the feedstock. The oil is heated in a vaporizer and the resultant vapors are carried by a hydrogen-rich gas into a gas tube that is fitted with a multiplicity of burners. The individual flames impinge on the surface of a water-cooled drum (Figure 14). A portion of the Carbon Black that is generated is deposited on the roller while the rest enters the filter system. In the next stage the two Carbon Black streams are combined. Onward processing is then similar to the Furnace Black process.

While it is possible to control the raw material fed by the carrier gas stream, the air has free access. However, despite this restriction, the Gas Black method allows the production of Carbon Black with primary particle sizes ranging from 10 to 30 nm. The tradeoff is less flexibility in defining the structure. However, this is not necessarily a disadvantage as Gas Blacks are inherently characterized by a loose structure and exceptional dispersibility.

While in the past these types of Carbon Black were used predominantly in tire tread formulations, they are now used almost exclusively in pigment applications where the fine-particle Gas Blacks are of particular importance (Figure 15).

As a result of contact with oxygen at high temperatures, acidic oxides form on the surface of the Carbon Black particles. In contrast to Furnace Blacks, Gas Blacks undergo an acidic reaction when suspended in water.

Oxidative post-treatment using nitrogen dioxide, ozone or other oxidants also make it possible to further increase the acidic surface groups significantly. These treated Carbon Blacks are used mostly in the Specialty Carbon Black sector, e.g. in the coating and ink industries. The majority of Gas Blacks are re-treated oxidatively.

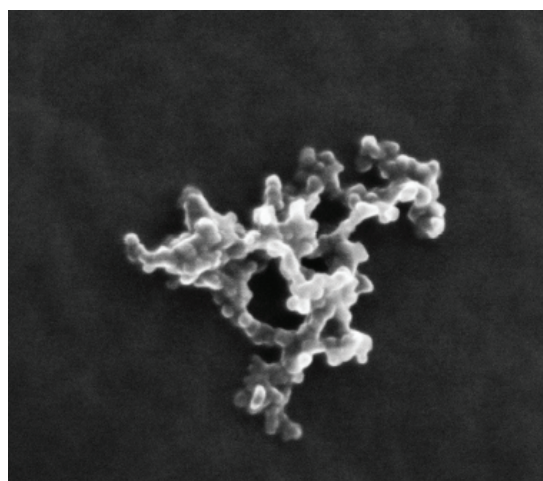

Figure 15:
Electron microscope view
of Gas Black particles
(COLOUR BLACK FW 285)

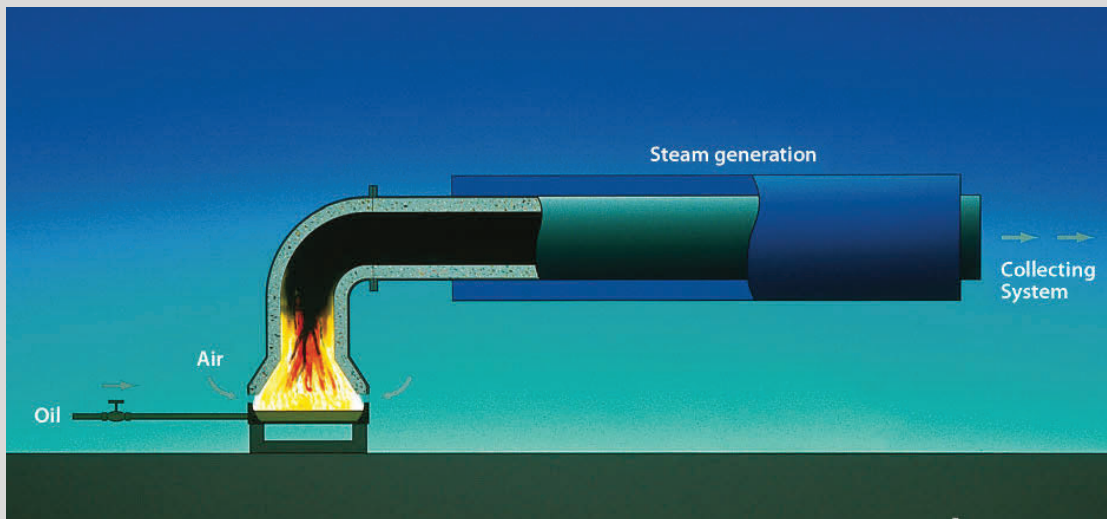

Figure 16:
Scheme of Lamp Black production process

2.2.3 Lamp Black Process

The Lamp Black process is the oldest commercial Carbon Black production process. However, today's Lamp Black production units have very little in common with the ancient Carbon Black ovens. Smoking chimneys and settlement chambers have long since given way to highly sophisticated filtering systems.

The Lamp Black apparatus consists of a cast-iron pan that holds the liquid feedstock, which is surmounted by a fire-proof flue hood that is lined with refractory bricks. The air gap between the pan and the hood, as well as the vacuum present in the system, help regulate the air supply and thus enable the manufacturer to fine tune the Carbon Black's ultimate properties. Although the radiated heat from the hood causes the raw material to vaporize and partially combust, most of it is converted to Carbon Black (Figure 16).

In order to separate the solids, process gases containing Carbon Black are passed through a filter after the cooling stage. Onward processing is similar to that of the Furnace Black method described in section 2.2.1.

Although different types of Lamp Blacks were produced in the past, the method was eventually standardized to yield only one type of Specialty Carbon Black and one type of Rubber Carbon Black. These Carbon Blacks are characterized by a broad primary particle size distribution ranging from approximately 60 to over 200 nm (Figure 17) and are widely used in special applications.

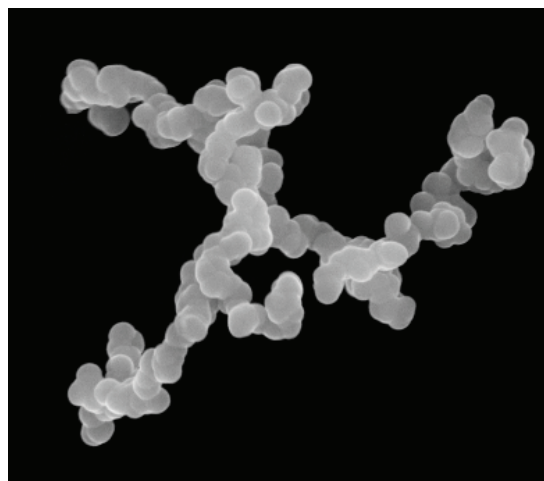

Figure 17:
Electron microscope view of Lamp Black particles

2 Manufacturing Process

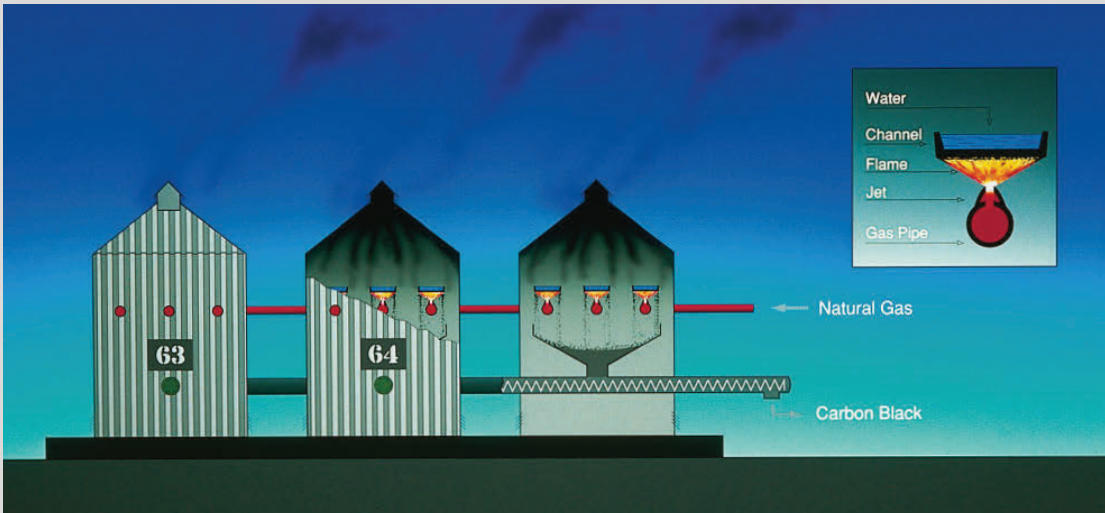

Figure 18:
Scheme of Channel Black
production process

2.2.4 Channel Black Process (historical)

Developed in the United States in the middle of the last century, this Carbon Black production process is based on the incomplete combustion of natural gas. Similar to the Degussa Gas Black process, natural gas flames from a vast number of small burners impinge on water cooled channels (Figure 18).

The reasons were the limited yield of the raw material (3 – 6 %) and the environmental hazard posed by the emission of very fine Carbon Black particles. The thick black smoke billowing from Channel Black plants, called “hot houses,” could be spotted miles away.

Since the 1950s, however, the Channel Black method continuously lost ground in the rubber industry. Following the oil crisis in the 1970s the process was discontinued in the US.



Figure 19:
Historic view of a Channel
Black production

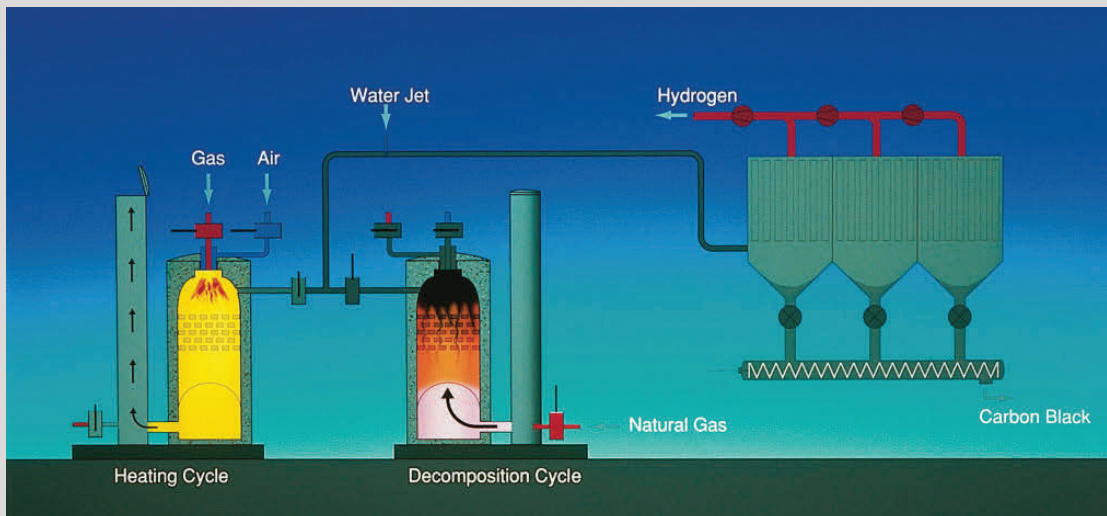

Figure 20:
Scheme of Thermal Black production process

2.3 Thermal Decomposition Processes

2.3.1 Thermal Black Process

This method of producing Carbon Black is a non-continuous or cyclic process, with natural gas as the most commonly used feedstock, although higher grade hydrocarbon oils are also used. A Thermal Black plant delivers maximum efficiency when operated in a tandem mode. It consists of two reactors operating alternately in cycles lasting five to eight minutes. One of which is heated with a natural gas or oil/air mixture while the other is fed with pure feedstock which undergoes thermal decomposition (Figure 20).

One could also include the Thermal Black method in the group of thermal-oxidative processes, with the distinction that the energy generation and the decomposition reaction are not simultaneous. However, the fact that the actual Carbon Black formation occurs in the absence of oxygen and at decreasing temperature, results in Carbon Black properties that are markedly different from those achieved by thermal-oxidative processes.

Thermal Blacks form relatively slowly, resulting in coarse primary particle sizes ranging from 300 to 500 nm (Figure 21), referred to as medium thermal. However, formerly when using only natural gas as feedstock it was possible to dilute it with inert gases which would produce a Thermal Black composed of primary particles in the range from 120 to 200 nm. This was referred to as fine thermal, the latter has virtually disappeared from the market.

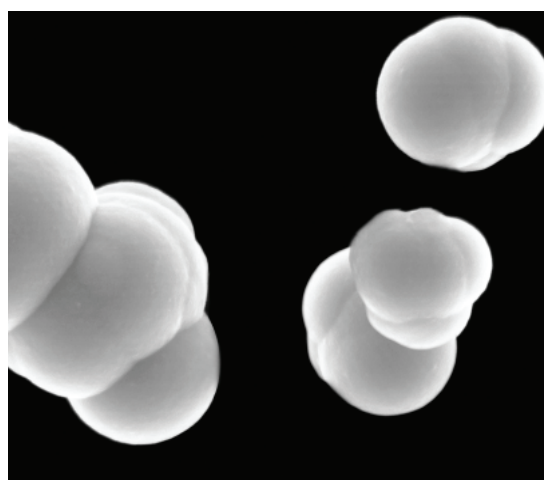

Figure 21:
Electron microscopeview of Thermal Black particles

2 Manufacturing Process

2.3.2 Acetylene Black Process

At higher temperatures, exothermic decomposition of acetylene yields carbon and hydrogen, forming the basis of the Acetylene Black process. Hydrocarbons are usually added to acetylene in order to prevent reactor temperatures from rising due to the exothermic reaction. Once the reaction mixture has cooled down, the Carbon Black is separated from the hydrogen.

The way Acetylene Blacks are created markedly distinguishes them from thermal-oxidative Carbon Blacks. Although the median primary particle size of Acetylene Black is in the same range as that of some Furnace Blacks (30 to 40 nm), the structure diverges noticeably from the spherical form (Figure 22).

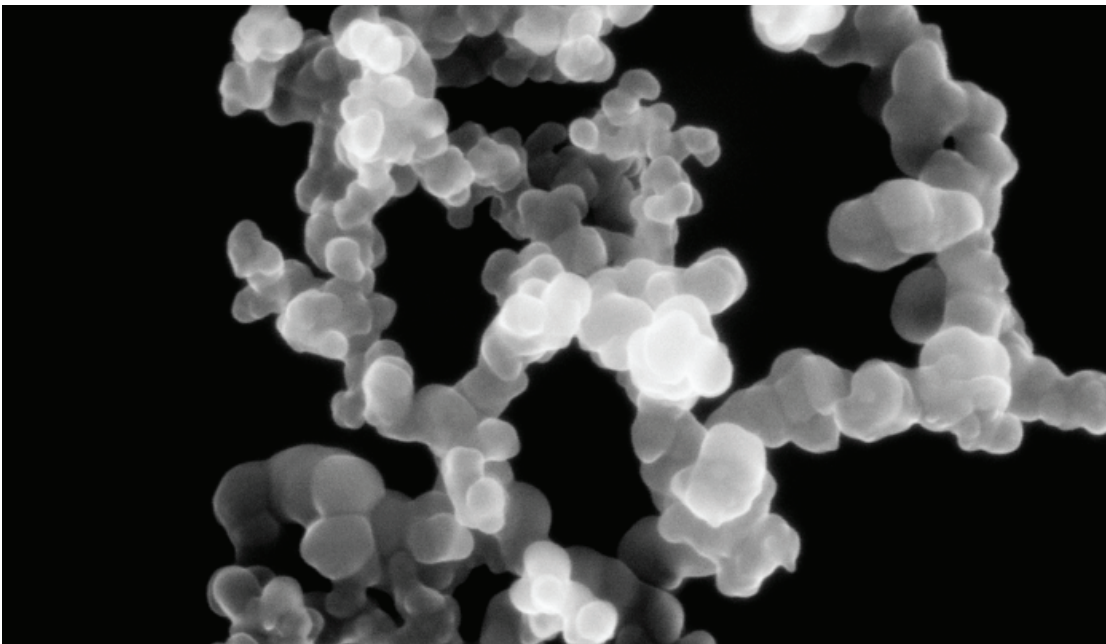

Figure 22:
Electron microscope view
of Acetylene Black particles

2.4 Carbon Black Dispersions, Compounds, Plastic and Rubber Masterbatches

Carbon Blacks can also be delivered to the customer in the form of dispersions, which are used to address special dispersibility issues at the customer's site and also keep pollution levels as low as possible during onward processing. Here a Carbon Black is dispersed in a variety of liquid and solid media in a wide range

of concentrations. The type of Carbon Black and base media are usually specified by the customer leading to a variety of products referred to as Carbon Black preparations. These compounds are classified based on their external appearance (Table 3).

Carbon Black Compounds	Properties
Aqueous Dispersions	Liquid to paste-like products
Pre-Dispersions	Powdery products containing water, solvents, wetting agents or softeners
Pastes	Paste-like products containing resins, softeners, wetting agents, etc.
Chips	Solids, e.g. Carbon Black/nitrocellulose compounds
Plastic Masterbatches	Granulated concentrates with up to 50 % Carbon Black content
Rubber Masterbatches	Carbon black-filled rubber, also in powder form
Oil Pellets	Oil-containing granules for printing inks

Table 3:
Carbon Black compounds



3 Properties of Carbon Black



The obvious property of Carbon Black is the deep black color, which is included in the designation in many languages. Carbon Black is classified as a solid and is initially formed as an aerosol or free-floating particles. This is why just-formed Carbon Black has a flaky appearance and is referred to as fluffy Carbon Black at this stage.

As shown by chemical analysis, non-treated Carbon Black consists of almost pure carbon. Nevertheless, using the periodic table designator "C" to describe the product would be misleading and therefore not particularly helpful.

To characterize Carbon Black, several physical and chemical properties have to be taken into account. Further insights are only possible after incorporating the various types of Carbon Black into the mediums chosen for its possible applications.

Particle Surface

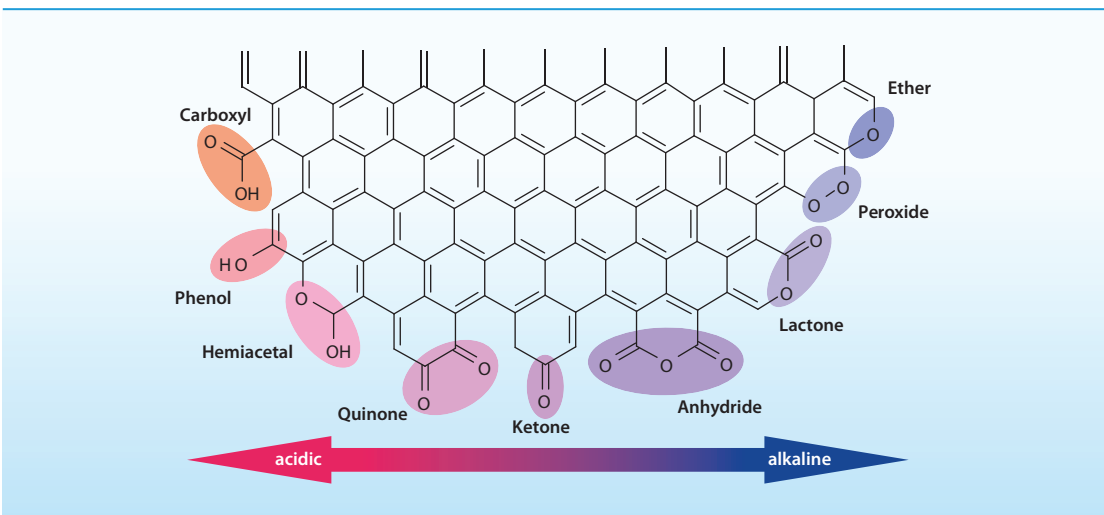

Figure 23: The surface of Carbon Black can bind oxygen in the form of acidic or alkaline functional groups.

3.1 General Physical and Chemical Properties

The composition described below refers to all Carbon Black grades, regardless of the production method used. Process-related variations have already been addressed in the description of the various methods in use today for obtaining Carbon Black. Without the use of photographic image analysis the primary particles of Carbon Black cannot be seen with the naked eye. It takes the tremendous magnifying power of a scanning electron microscope (SEM) to show that Carbon Black consists of chain-like clusters composed of spherical particles, the so-called primary particles. The product is not supplied in the form of isolated primary particles, but as larger, tightly bonded aggregates which form the primary building blocks. The primary particles vary in size and shape to impart specific application properties. The primary particle size is mentioned to indicate the application properties of a given product. The aggregates typically form micro-scale agglomerates during production, present in the supplied powders or pellets.

Figure 24 depicts an SEM view of a single particle. The formation of spherical, branched aggregates, where the primary particle can have diameters between 10 and 500 nm, is typical of products that develop from the gaseous phase. As we cannot see and measure primary particles without involving expensive equipment and time consuming methods this form of Carbon Black has led to the definition of two properties

that are of primary significance when it comes to characterizing Carbon Blacks and defining their suitability for specific applications:

- The specific surface area (m²/g) of Carbon Black is a function of primary particle size. Looking at geometric proportions, we can determine that smaller Carbon Black primary particles have a higher specific surface area.
- The structure designates the three-dimensional arrangement of primary particles in the aggregate. Extensive interlinking or branching characterizes a “high structure”, whereas less pronounced interlinking or branching indicates a “low structure”.

Electron microscopy combined with X-ray structural micro-analysis, shows that these primary particles consist of concentrically arranged, graphite-like crystallites. By partially fusing together, the graphite layers are often twisted into each other, exhibiting a disordered state. A single primary particle can contain up to 1,500 of such crystallites.

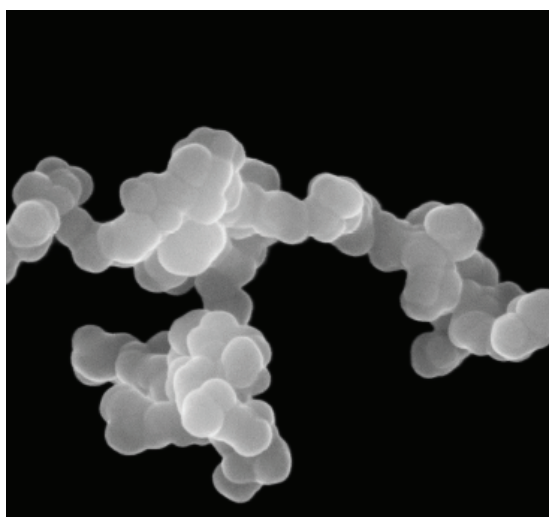

Element	Content (% of wt.)
Carbon	96 – 99.5
Hydrogen	0.2 – 1.3
Oxygen	0.2 – 0.5
Nitrogen	0 – 0.7
Sulfur	0.1 – 1.0
Residual Ash	< 1

Table 4:
Typical elemental Carbon Black composition

Figure 24:
Scanning electron microscope view of a Carbon Black aggregate consisting of fused primary particles (magnification: x 120,000)

3 Properties of Carbon Black

Carbon Black can thus be considered as a highly disordered form of graphitic carbon. By heating the substance to 3,000°C under inert conditions it develops into an ordered graphitic formation.

Turning back to chemical analysis, we see that, besides carbon the elementary analysis of normal Carbon Black also yields minute quantities of oxygen, hydrogen, nitrogen and sulfur (Table 4). Most of these elements are concentrated on the surface of the Carbon Black. The removal of traces of organic elements is possible with the use of special solvents. The Carbon Black extraction based on toluene mostly results in values less than 0.1 %.

Partially, the element of hydrogen is directly fused to the carbon element. However, together with oxygen, another portion forms surface-bound functional groups that can be identified by analysis, both qualitatively and quantitatively. Carbonyl, carboxyl, pyrone, phenol, quinone, lactol and ether groups have been identified as the oxygen-containing groups that may be bound to the surface of the Carbon Black particle. Heating the substance up to 950°C, in the absence of oxygen, results in separation. This explains their designation as “volatile matter”.

Oxygen containing functional groups on the Carbon Black surface can also be created through specific oxidative post-treatment. Oxygen content levels of 15 % and higher are possible. These Carbon Black types are especially suitable for treatment with polar binders.

Sulfur is present in a variety of forms: in its elementary form, as a bound molecule and in an oxidized state. High sulfur contents impart a certain acidity to the Carbon Black.

Among the physical properties of Carbon Black, the following two are important:

Density: According to literature and depending on the method used, it may vary from 1.7 to 1.9 g/cm³.

Electrical Conductivity: This aspect is usually not measured in the Carbon Black itself but in the compound containing the Carbon Black, i.e., a polymer or binding agent. Conductivity of a filled polymer increases with the specific surface area and the structure of the incorporated Carbon Black. It is also dependent on the Carbon Black concentration and dispersion as well as on the type of polymer or binding agent used (Figure 25).

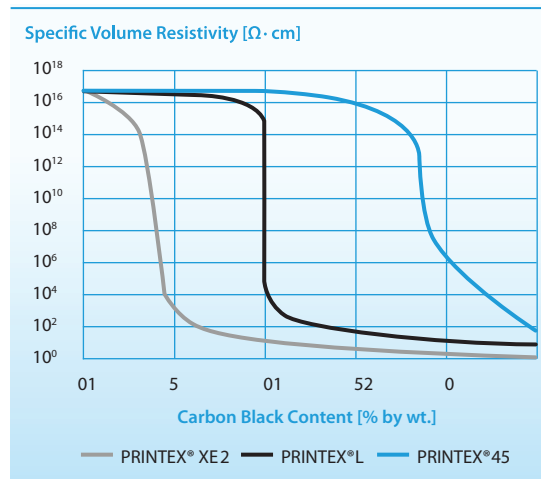

Figure 25: Specific volume resistance curves for filled HD polyethylene samples relative to Carbon Black content

Nitrogen, when present, is usually contained in the graphite grid. Sulfur and nitrogen contents are contingent upon feedstock type and quality.

Carbon Black also contains traces of metals. The amounts and types depend on the feedstock used. Table 5 provides an overview of the metals and their relative content based on OEC’s Rubber and Specialty Carbon Blacks.

Metals Present in Carbon Black

Element	Content in ppm
Antimony	< 10
Arsenic	< 10
Barium	< 10
Cadmium	< 1
Chrome	< 5
Cobalt	< 5
Copper	< 5
Lead	< 10
Nickel	< 10
Mercury	< 1
Selenium	< 10
Zinc	< 10

Table 5: Typical concentrations of trace metals

3.2 Definition of Carbon Black

Having described the various processes for obtaining Carbon Black and the resulting product properties, we can summarize the definition of Carbon Black as follows:

Carbon Blacks are chemically and physically defined products obtained under controlled conditions. Insofar as they are not treated oxidatively, they consist of more than 96 % pure carbon particles and minute quantities of oxygen, hydrogen, nitrogen and sulfur. The negligible amount of organic substances on the surface of the Carbon Black particle (mostly less than 0.1 %) can be extracted using toluene. Metal concentrations are likewise negligible. Primary Carbon Black particles, ranging from 10 to approx. 500 nm, fuse into chain like aggregates. This defines the structure of individual Carbon Blacks.

Carbon Blacks that are treated oxidatively differ from those that are not, in the sense that they may contain up to, and sometimes exceeding, 15 % oxygen.



On the other hand, soot (chimney soot and diesel exhaust soot) is a by-product of the uncontrolled combustion of hydrocarbons. Obtaining precise data on the composition of soot is virtually impossible because the conditions under which it is created are fluctuating, precluding any consistency in terms of

quality and properties. Soot can be differentiated from Carbon Black based on inorganic and organic impurity contents. Chimney soot, for instance, may have a carbon content of less than 50 %, an extract content of more than 15 % and an ash content of more than 20 %.

3 Properties of Carbon Black

3.3 Test Methods, Chemical and Physical Data

For a long time, characterizing Carbon Blacks was a question of determining different shades of black with the human eye. Precise data on reinforcing effects was available only to a limited degree. What exactly the characteristics of a particular Carbon Black were and what it could be used for were questions that could not easily be answered. In many cases, the development of new Carbon Black grades happened before the characterization of their properties, very much a “hit-and-miss”-situation.

Following the introduction of the Furnace Black method, initially there were only a few basic grades listed. In the mid-1960s it was discovered that the addition of alkaline metal salts during the production process could be used to influence the Carbon Black structure. This was the first major advancement which led to a broader typology of Furnace Blacks.

For the application to tire treads, high-structure Carbon Blacks were introduced in the rubber industry in the 1960s to improve abrasion resistance. To determine their structure a quick test method had to be developed.

Following a series of comparative tests, DBP (dibutyl phthalate) absorption ultimately became the preferred tool for determining Carbon Black structure.

Difficulties arose in the early 1970s when advances in technology led to a new category of reinforcing Carbon Blacks in Furnace Black production. Compared to the standard grades available at the time these so-called new technology or improved blacks showed improved abrasion resistance without any apparent change in the iodine number. The differences between these new technology blacks and standard Carbon Blacks were not easily detectable with the methods available at the time. Therefore, physical and chemical characterization methods had to be developed in order to establish production parameters, which ensured that the correct Carbon Black characteristics were achieved. One of these new methods focused on the determination of the Carbon Black surface area (CTAB adsorption cf. p. 32).

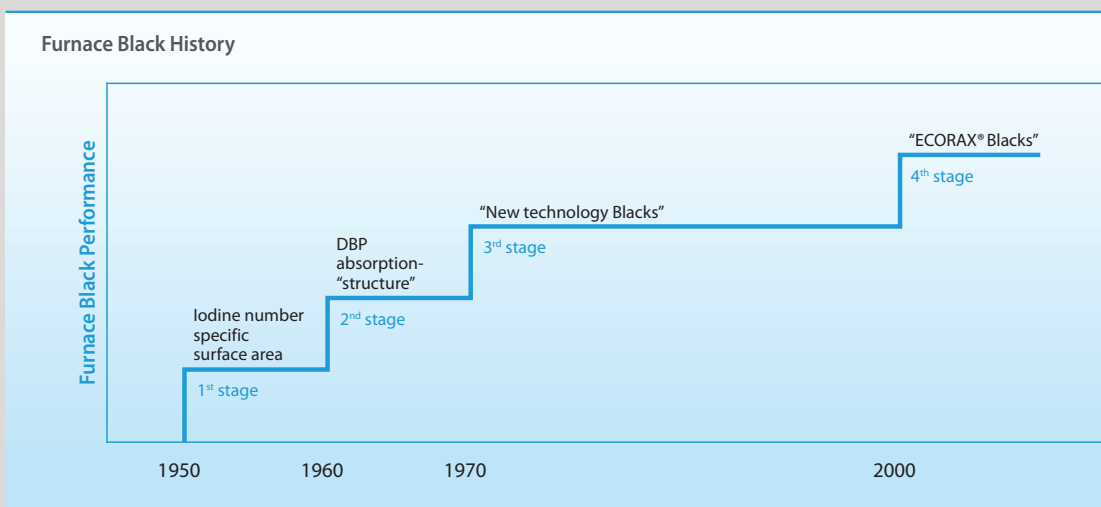
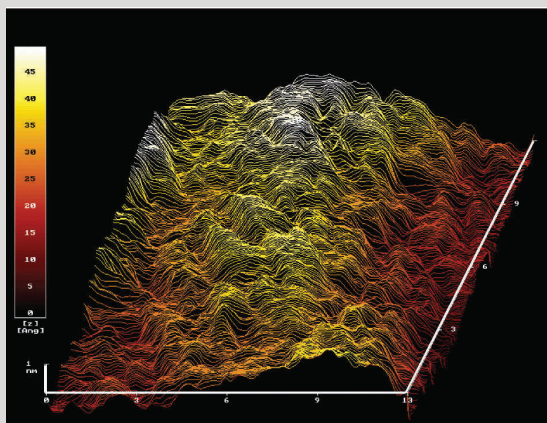

Figure 26a: Furnace Black history

Further development and refinement of Orion's Carbon Blacks for the rubber industry has led to specifically surface structured blacks (ECORAX® grades), which were first introduced at the beginning of the millennium. These Carbon Blacks feature a rougher micro-surface in the nanometer range and deliver improved dynamic properties in vulcanized rubber compounds versus comparable ASTM Carbon Blacks.

The development of PUREX® Carbon Blacks was another step towards more sophisticated and product orientated Carbon Blacks. These Carbon Blacks address the needs of the rubber industry for clean and easily dispersible soft blacks, especially those used in the production of mechanical rubber goods for the automotive industry.

With hindsight, we can say that the development of the electron microscope in the 1940s proved a major milestone in terms of analyzing Carbon Black and specifying different grades for different applications. Where empirical methods used to be the only option for characterizing Carbon Blacks, this new technology made it possible to conduct scientific analyses based on particle diameter, particle aggregation and even particle classification in terms of shape and surface details. The research showed that virtually no two Carbon Black particles are exactly alike.



Higher surface roughness for ECORAX® black due to smaller crystallites and more disordered arrangement of crystallites

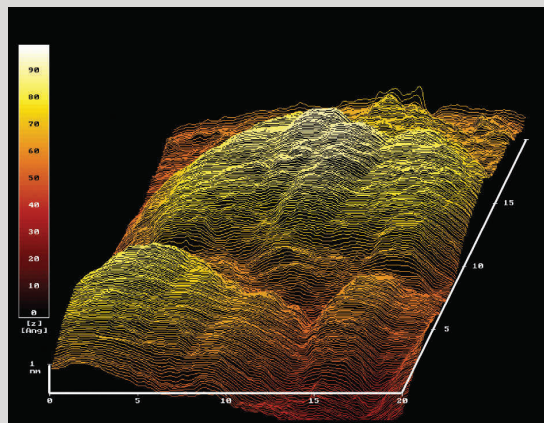

Conventional Furnace Blacks

Figure 26b:
Scanning tunneling
microscopy (STM)

3 Properties of Carbon Black

All Carbon Black characterization methods existing today are used to define collective properties, which are based on the sum of properties determined for the individual particles. This means that we are dealing with a maximum variation of particle properties in a range with statistical maximum. It is up to the skilled technician to adjust the peak of the distribution curve at a specific value and define the width of the curve. As long as geometric data is what is being processed and analyzed, the electron microscope is a helpful tool in determining the distribution curve. Other parameters, like conductivity, cannot be determined for the individual particles.

As already pointed out, the average primary particle size and the average aggregate size form the primary characteristic data. However, the particle size distribution and the aggregate size distribution are at least as important. As an alternative to lengthy electron microscope analysis a number of methods have been developed to enable a quicker characterization and allow conclusions to be drawn for subsequent Carbon Black applications. While various surface characterization methods have gradually replaced those for particle size determination, the aggregate size distribution is now determined via specialized methods such as sedimentation, ultra-centrifugation and light refraction.

De facto there are various characterization methods in use today, which indicate that a general characterization of Carbon Black is impossible. It is necessary to specifically adapt identifying methodologies to the various areas of application.

Most Carbon Black properties are determined based on industry standards, which have been developed by the German Institute of Standardization (Deutsches Institut für Normung e.V. - DIN), the International Organization for Standardization (ISO) and the ASTM International (formerly known as the American Society for Testing and Materials). These standards are not only used as a measure by which Carbon Blacks are characterized, but also as a quality assurance tool for the production process (Table 6).

In addition to these Carbon Black reference profiles, a number of more practical testing methods are used today, especially for testing Rubber Carbon Blacks in relation to their end use segments. These tests may be conducted in standard rubber formulations and are used to establish characteristic and consistent profile data on the impact of the Carbon Black in the rubber compound.

Obviously, these methods offer only a glimpse of the comprehensive systems available for testing and evaluating Rubber Carbon Blacks. Special testing methods also exist for Carbon Black applications in the plastics, coatings and printing inks industries. However, we will not expand on them any further here.

In the following chapters the main measurement methods are described in more detail.



1) Determination of toluene extract



2) Measurement of nitrogen surface area/STSA

Figure 27:
Test methods

Standardized Carbon Black Test Methods

Description	ISO	ASTM	DIN
Surface Area Iodine Adsorption Nitrogen Surface Area/STSA	1304 4652/18852	D 1510 D 6556	66132
Structure/Rheology OAN COAN Oil Absorption	4656 4656 787/5	D 2414 D 3493	*)
Colorimetry Jetness Tint Strength	5435	D 3265	55979
Chemical Analyses Volatile Components Ash Residue Moisture Sieve Residue Non-Dispersible Matter Toluene Extract Transmittance of Toluene Extract pH	1125 787/2 787/18 6209 3858 787/9	D 1506 D 1509 D 1514 D 7724 D 4527 D 1618 D 1512	53552 53586 *) *) *) *)
External Appearance/Texture and Handling Properties Pour Density Individual Pellet Hardness Pellet Size Distribution	1306 8511	D 1513 D 5230 D 1511	**)

Table 6:
Carbon Black test methods.
*) DIN EN ISO method
**) DIN ISO method



3) Measurement of oil absorption capability (OAN)



4) Measurement of iodine adsorption

Figure 27:
Test methods

3 Properties of Carbon Black

3.3.1 Determination of Surface Area

The specific surface area of a Carbon Black is mainly derived from the particle geometry using adsorption methods. Iodine adsorption, measured in mg/g, is the most common technique.

Iodine adsorption is a quick test method for dry Carbon Black. Surface groups and adsorbed substances influence this specification method. For the iodine number to reflect the real surface area, it is important that neither increased amounts of volatile matter nor higher toluene extracts disturb the measurement. This in turn limits this method to Furnace Blacks with low toluene extractions and Lamp Blacks. Furnace Blacks with high contents of solvent extractable material, Gas Blacks and treated Carbon Blacks cannot be analyzed using this method. That is mainly why this parameter is usually not stated when dealing with Specialty Carbon Blacks.

CTAB adsorption, introduced primarily for the characterization of improved Carbon Blacks, comes closest to an accurate determination of the geometric surface, i.e., not including the pores. That is because cetyl trimethyl ammonium bromide (CTAB) has a greater space requirement than nitrogen. This is also why the CTAB number correlates well with particle size, allowing for meaningful predictions on Carbon Black properties and behavior in the application environment.

More modern methods to measure the surface area are the **BET multipoint nitrogen absorption** and the associated **STSA** (Statistical Thickness Surface Area). It has always been recognized that the multipoint nitrogen surface area was the most accurate way of measuring the total surface area of the primary particle. However, limitations in equipment, did not allow this to become a standard. With the introduction of new automated test equipment it became possible to receive the results of the BET multipoint and the STSA with minimum efforts and in a much shorter testing time. It is generally accepted that a combination of these two measurements more clearly defines the surface area of a Carbon Black. This allows better process control and gives values, which relate to the Carbon Black's performance potential. Today STSA has basically replaced CTAB surface area.

Conversely, the particle size itself can be used to determine the **geometric surface**. This value is obtained from electron microscope photographs, which make it possible to measure the particle size, determine the distribution curves and calculate the surface area values. Although it is a very important tool in the Carbon Black industry, the method is too time-consuming and complex and the equipment is too expensive for obtaining profile data for everyday use.



3.3.2 Determination of Structure

The structure of Carbon Black aggregates can only be determined indirectly.

The most commonly accepted method is based on oil absorption. In this test, paraffin oil (formerly dibutyl phthalate, DBP) is added by means of a constant-rate burette to a sample of the Carbon Black in the mixer chamber of an absorptometer. As the sample absorbs the oil the mixture changes from a free-flowing powder to a semi-plastic continuous mass. This leads to a sharp increase in viscosity, which is transmitted to the torque-sensing system of the absorptometer. The end-point of the test is given by a pre-defined torque level. The result is expressed as the oil absorption number (OAN), in ml/100 g. A high OAN number corresponds to a high structure, i.e. a high degree of branching and clustering of the aggregates.

Mechanical stress can be applied to destroy agglomerates. This effect is used for determining the structure based on the oil absorption of a compressed sample (COAN). Following four repeated applications of pressure at predefined levels, the oil absorption of the mechanically stressed Carbon Black is measured by the conventional oil absorption method. As a general rule, COAN values are lower than OAN values.

Another parameter, Carbon Black oil absorption according to ISO 787/5, is measured using the so-called flowpoint method. The flowpoint registers the maximum quantity of oil (usually linseed oil) that can be added to Carbon Black and still allow for a non-deliquescent cone to form from the mixture. Although the method is not the most accurate, oil absorption is an important indicator in coating applications because a high oil absorption level points to a high binding agent requirement. The Carbon Black structure and particle size, but most of all density and surface chemistry, all have an effect on oil absorption.

3.3.3 Colorimetric Characterization

Jetness refers to the intensity of blackness that is achievable. The most accurate instrument for measuring what are often very minute differences is the trained eye which can differentiate between up to 100 different shades of black. A method for measuring residual reflection (<0.5 %), invented by OEC, became a standard known as DIN Norm 55979. A Carbon Black sample mixed with linseed oil and measured with a spectral photometer results in an M_V value. The finer the Carbon Black particle is, the higher the M_V value would be (Figure 28).

A refined version of the paste method described above consists of determining the M_V factor in an alkyde/melamine resin lacquer. The jetness achieved is mapped against various group standards and is indicated as a relative blackness value figure M_{Vr} for optimum reproducibility and consistency.

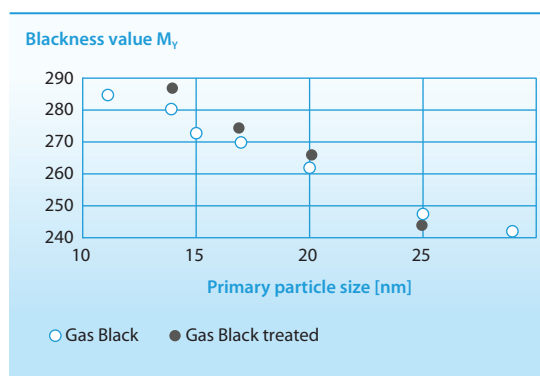

Figure 28: Primary particle size and jetness

Tint strength refers to a colorimetric parameter: it is the coloring ability of a Carbon Black as measured against a white pigment (zinc oxide). However, tint strength is influenced by the particle size and structure but also, to some extent, by the particle size distribution. The finer the Carbon Black particles are, the greater the tint strength is, an indirect indicator of surface or particle size specification. On the other hand, a lower structure causes greater tint strength. Thus, tint strength by itself can often lead to a serious misinterpretation of the reinforcing capability of a Carbon Black and should therefore always be viewed in relation to both structure and surface area.

The tint strength as well as the relative Grey Value G_{Vr} (based on a polymer-coating system) will be given as a percentage relative to a standard of Specialty Carbon Black.

3 Properties of Carbon Black

3.3.4 Chemical and Physical Measurements

The **volatile matter content** gives an indication of the Carbon Black's oxygen concentration and is determined by heating the Carbon Black up to 950°C. This parameter is especially important for testing Carbon Blacks that have been post-treated.

The **ash content** points to the level of inorganic impurities coming primarily from the feedstock - iron, calcium and silicon are among the most common. Gas and Acetylene Blacks are characterized by a very low ash content due to their production process.

The **sieve residue** provides information on particulate impurities which may contain metal or ceramic particles originating from the production unit or coke particles formed during the production process.

As a result of their high adsorbency, **moisture** is an issue when storing Carbon Black. High-structure Carbon Blacks, and in particular oxidatively post-treated Carbon Blacks, are more likely to have elevated moisture content levels.

The **pH** of a Carbon Black is measured in an aqueous suspension. Untreated Carbon Blacks have a different pH depending on the process used: Gas Blacks are always acidic because of their oxidized surface. Furnace Blacks, on the other hand, are generally alkaline because small quantities of basic oxides are present on the surface. Lamp Blacks, Thermal Blacks and in some cases also Acetylene Blacks are characterized by alkaline to neutral reactions.

3.3.5 Physical Appearance and Handling Properties

To determine the space requirement of powder and pelletized Carbon Blacks either the **bulk or pour density**, or the compacted or tapped density, is measured. The structure is reflected by pour density. High-structure Carbon Blacks show a lower bulk density than low-structure Carbon Blacks.

In the case of pelletized Carbon Blacks, the **pellet hardness** is a significant quality parameter as it gives an indication of pellet fragility and hence of the resistance to attrition rate. This resistance is characterized by pellets being destroyed and ultimately ground to dust by friction. While softer pellets make for better dispersion, their inherent propensity towards finesse may create handling issues. The **pellet size distribution** is a parameter that affects the flow characteristics of pelletized Carbon Blacks. A uniform pellet size means a lower bulk density, hence ensuring optimum flow behavior.



Figure 29:
Control room of a
Carbon Black plant

3.4 Specifications and Quality Assurance

Some of the parameters described above are part of the Carbon Black specifications decided on jointly between the customer and the manufacturer. Although these mainly concern surface and structure specifications, they may also address specific requirements as they relate to the Carbon Black application.

Key parameters are checked at regular intervals during the production process as part of production control activities.

One aspect which is important to both manufacturers and users of Carbon Black is the continued consistency in type and quality. This is a direct function of the production process and process control (Figure 29). Quality assurance, in terms of product uniformity and reproducibility, is as important as meeting the customer's individual specifications.

Most manufacturers therefore incorporate statistical process control (SPC) in the Carbon Black production process. SPC is a system that builds on universally accepted specifications and guidelines for quality assurance.

The most important target values for individual rubber blacks, to ensure optimum production processes, were laid down by ASTM International (ASTM D 1765), e.g., parameters for iodine adsorption and OAN absorption (Figure 30).

These parameters are determined at regular intervals throughout the production process. They not only ensure a smooth production process, but also help achieve optimum consistency in terms of end product quality. The "Capability Indices", C_p and C_{pk} , give an indication of parameter variances and their deviation from target values.

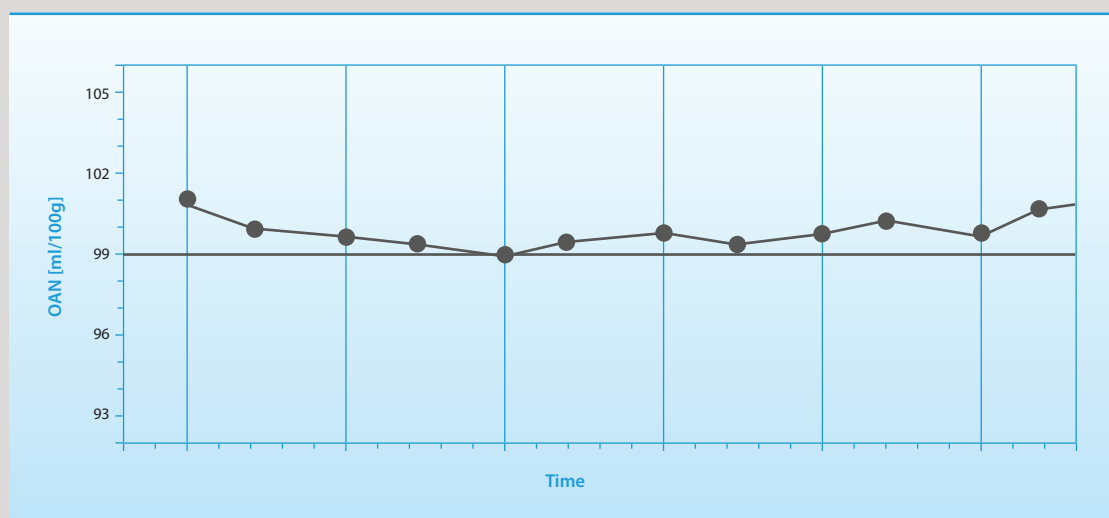

Figure 30: Process control chart

3 Properties of Carbon Black

3.5 Characteristic Data of various Production Processes

The various production processes for obtaining Carbon Black have their advantages and each process is characterized by a certain product range. The key parameters, as shown in Table 7, provide an overview of the characteristic data for the main Carbon Black production processes.

Each process shows a characteristic primary particle diameter distribution curve. An electron microscope image of the individual Carbon Black type is used to

determine the quantity and size of the primary particles, which then yields the number of specific diameter clusters.

Figure 31 shows the primary particle size distribution curve for each of the main production methods. Fine Carbon Blacks (Gas Blacks) for instance are clustered in a relatively narrow primary particle size range. Coarser Carbon Blacks exhibit flatter curves.

Carbon Blacks/Production Processes

		Thermal-Oxidative Decomposition			Thermal Decomposition	
		Lamp Black	Gas Black	Furnace Black	Thermal Black	Acetylene Black*
Nitrogen Surface Area	m ² /g	16–24	90–500	15–450	6–15	approx. 65
Iodine Adsorption	mg/g	23–33	n.a.	15–450	6–10	approx. 100
Primary Particle Size (arithm. mean)	nm	110–120	10–30	10–80	120–500	32–42
OAN	ml/100g	100–120	n.a.	40–200	37–43	150–200
Jetness M _y		200–220	230–300	210–300	170–190	225
Tint Strength	%	20–35	90–150	50–160	approx. 20	n.a.
Volatile Matter	%	1–2.5	4–24	0.5–6	0.5–1.0	0.5–2,0
pH**		6–9	4–6	6–10	7–9	5–8*

Table 7: Carbon Black variances for different production processes

* Pressureless process

** Treated Carbon Blacks may have a pH as low as 2

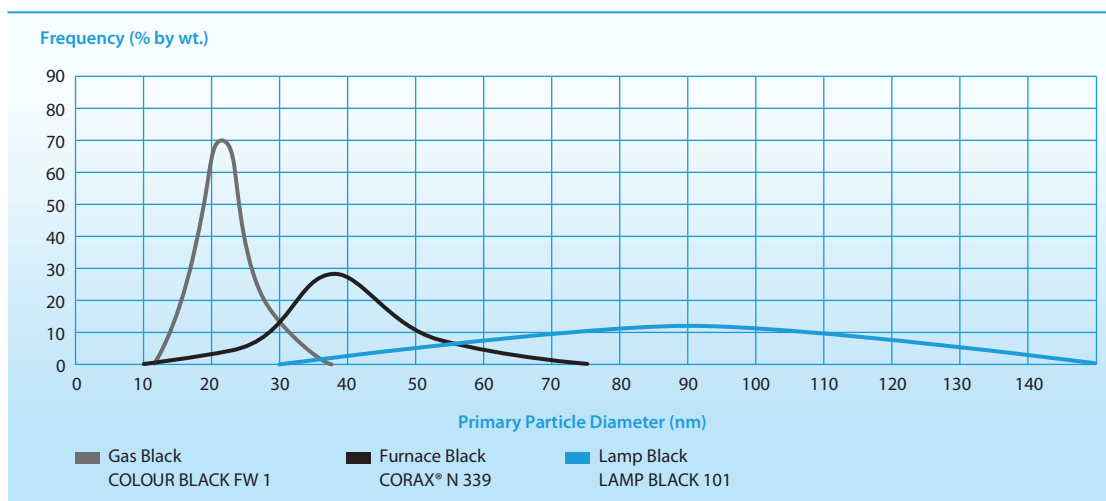
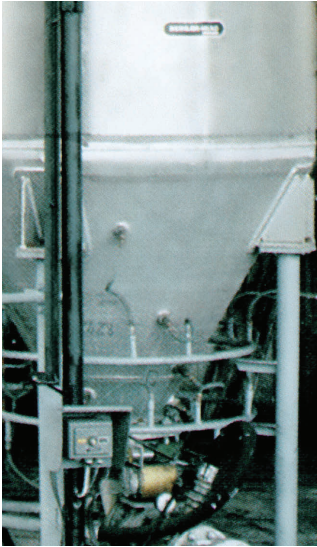

Figure 31: Distribution curves for primary particle diameters



4 Handling



Significant advances have been made in the area of handling and shipping granulated and powdery goods in recent years. New systems for perfectly sealed storage and transportation in particular have greatly benefitted the Carbon Black industry. Carbon Blacks are marketed in the form of powder Carbon Black (Specialty Carbon Blacks) and pelletized Carbon Black (Specialty Carbon Blacks and Rubber Carbon Blacks). The handling systems differ substantially depending on the type of Carbon Black for which they are designed.

Depending on their type, **powder Carbon Blacks** can more or less easily be fluidized pneumatically. This makes it possible to convey them in large quantities over relatively long distances using high air volumes. Screw conveyors are used mainly for shorter distances.

Due to their low bulk density and relatively poor flow characteristics, powder Carbon Blacks are not usually shipped in rigid vessels or silos, but rather packaged in bags or FIBCs (Flexible Intermediate Bulk Container) as shown in Figure 32.



1) FIBC



2) Paper bags

Figure 32:
Carbon Black packaging

Pelletized Carbon Blacks, on the other hand, are much easier to handle. Despite their significantly better flow and conveying properties, the pellet forms require special precautions to prevent the pellets from being crushed during transport. Otherwise, flow characteristics and onward handling may be significantly degraded, which could possibly lead to production downtime and equipment failure due to clogging. That is why conveyor belts and bucket elevators are still commonly used for intra-plant Carbon Black transfers. When pneumatic systems are used it is important to employ low velocity conveying systems (Figure 33).

One aspect to keep in mind is that wet-pelletized Carbon Black is usually characterized by a greater pellet hardness than dry-pelletized or oil-pelletized Carbon Black. The appropriate conveying system must be chosen depending on the pellet hardness, considering the strength of the pellets against the applied forces.

Dense-phase conveying systems offer the gentlest conveying of such materials while dilute-phase conveying and even dune-phase conveying are not recommended because the resulting damage to the pellets during transportation is too high. Short distances are best bridged using screw conveyors, fluid channels or vibratory feeders.

The transportation of Carbon Black in 25 kg bags is by far the least common. About 85 % of the global Carbon Black is delivered in bulk (road and rail cars) and semi-bulk containers such as FIBCs or customer owned IBCs (Intermediate Bulk Containers, so-called bins).



1) Pneumatic conveyor system for Carbon Blacks



2) Truck containers

Figure 33:
Carbon Black handling
and shipping

5 Product Safety



5.1 Toxicology

Human Experience

In decades of Carbon Black production and processing using a variety of methods, no significant hazardous effects have been registered.

Acute Toxicity

Carbon Black has an acute (oral) toxicity LD50 of > 8000 mg/kg bw. Carbon Black applied on the intact skin and to the eye of the rabbit does not cause irritating or corrosive effects. Carbon Black did not induce skin sensitisation effects in guinea pigs (OECD guideline 406). In humans, no cases of skin or respiratory allergies have been reported.

Repeated Dose Toxicity

Carbon Black has a NOAEL of 1 mg/m³ (respirable) after repeated inhalation of rats for 13 weeks. Based on human data, a NOAEL can be estimated at 2 mg/m³ (inhalable).

Chronic Toxicity

In the early 1990s, extended long-term inhalation studies with rats showed lung fibrosis and tumor development in the case where the lungs were overloaded with Carbon Black particles. Mice and hamsters did not develop lung tumors under similar testing conditions. Although the significance of effects seen in rats under overload conditions for human risk assessment is today still controversially discussed.

In October 1995, the International Agency for Research on Cancer (IARC) had evaluated available data on Carbon Black and amended its initial overall rating of Carbon Black from Category 3 to Category 2B ("possible human carcinogen") based on two long-term inhalation studies performed in rats under conditions of lung overload. Based on human (epidemiological) data, IARC concluded that there was "inadequate evidence" linking exposure to Carbon Black to cancer development in humans. In subsequent evaluations of Carbon Black in 2006 and 2010, IARC upheld its previous rating. As a consequence of the IARC evaluation, Carbon Black is now included in the Danish cancer list and classified as a D2 A substance (poisonous and infectious material) and in the Canadian Workplace Hazardous Materials Identification System (WHMIS) under the Canadian Environmental Protection Act (CEPA). The German MAK Commission reviewed Carbon Black in 1998. The overall rating of this commission is Category 3B ("possible human carcinogen") also based on the long-term inhalation studies on rats under conditions of lung overload.

Based on findings by the National Toxicology Program (NTP/USA) as well as the European (excluding Denmark) and American legislation regarding chemicals (OSHA), Rubber Carbon Blacks and Specialty Carbon Blacks do not exhibit Carbon a mutagenic, teratogenic or carcinogenic risk.

Ecotoxicology

Carbon Black is an inorganic water insoluble substance. For this reason its bioavailability for aquatic organisms is very low. In acute tests according to OECD test guidelines with fish, daphnia and algae, nominal concentrations of 1.00 mg/l showed no effects. Based on the physicochemical and acute toxicological data, no chronic effects and no bioaccumulation are to be expected in aquatic organisms. The

general guidelines for the examination of the biodegradability of substances (OECD, EEC-guidelines) can be used only for organic substances. Carbon Black is an inert inorganic substance with the structural formula "C" and is not biodegradable by microorganisms. The German commission for the evaluation of water polluting substances has classified Carbon Black as a "not water endangering" substance (KBwS-No: 1742).

5.2 Safety-Related Properties

Under normal application conditions Carbon Black does not pose a potential explosive hazard. However, in the presence of significant igniting energy, e.g., a welding torch, Carbon Black/air mixtures may explode. For this reason, Carbon Black sources must be removed or hermetically sealed prior to equipment repairs in the vicinity of welding processes or equipment generating high operating temperatures.

Carbon monoxide build-up is possible in sealed containers such as silos or in unventilated storage facilities. Due to the toxic and extremely flammable properties of carbon monoxide, ignition sources should be removed and self-contained air supply systems should be used.

Carbon Black should be stored under dry conditions. During activities where the workplace limit value valid for Carbon Black are exceeded, an air suction system should be in operation or work personnel be required to wear protective dust masks. For most countries the general dust exposure limit applies for Carbon Black. The country-specific OEL for Carbon Black can be obtained from our safety data sheets which are obtainable from our website. To prevent Carbon Black emissions and dust build-up, implementation of good engineering and housekeeping practices as well as effective dust removal systems are recommended.

Further details regarding safe handling of Carbon Blacks are described in the relevant safety data sheet (SDS).



Special Requirements

Many Carbon Blacks fulfill the governmental standards for additives that are used in articles that come into contact with food, drinking water and toys. For more detailed information, please contact the Product Stewardship and Health Department:

Orion Engineered Carbons GmbH
Hahnstraße 49
60528 Frankfurt am Main
Germany

phone +49 69 36 50 54 - 165
fax +49 69 36 50 54 - 784
sds.eu@orioncarbons.com

6 Applications



Once you consider its possible uses you will find that there are many answers to the question “What is Carbon Black?”

Indeed, the physical and chemical properties discussed so far hint at a broad spectrum of applications. The high degree of light absorption, for instance, is one aspect that makes Carbon Black so useful in the coatings, plastics and printing industries.

6.1 Rubber Carbon Blacks

The primary particle size, the aggregate formation and the surface activity have all led to the important application of Carbon Black as a reinforcing agent in rubber applications. These Carbon Blacks are most commonly referred to as Rubber Carbon Blacks.

The reinforcing effect of Carbon Black was discovered by accident rather than intentionally shortly after the turn of the 19th century. Until then zinc oxide was the substance of choice for eliminating the inherent stickiness of rubber. The discovery of the reinforcing properties of Carbon Black represented a new dawn for the Carbon Black, tire and automotive industries. Now tires with improved textile cord could be produced to last longer if Carbon Black is used as a filler in the rubber compound instead of zinc oxide.

However, it took until the early 1920s before Carbon Black was generally used to reinforce tire rubber and other rubber products. Soon it also became clear that

there were significant differences between the various types of Carbon Black, and that these distinctions evolved from processing characteristics and their effect on rubber properties. As a result, new typologies, such as MPC = Medium Processing Channel Black or HAF = High Abrasion Furnace Black, were established.

The demand for reduced rolling resistance and subsequently the labeling of tires steered the industry toward a solution for the truck and passenger car sector. The idea to use a suitable filler to achieve a lower rolling resistance inspired OEC to develop a new generation of Rubber Carbon Blacks under the brand name ECORAX®.

In the area of technical rubber components, the main criteria for modern Carbon Blacks are excellent dispersibility, processing reliability and quality consistency. The PUREX® family of Carbon Blacks developed by OEC for the MRG industry addresses these needs.

The following widely acknowledged typology of Carbon Blacks based on reinforcing properties has stood the test of time:

Hard Blacks:

High reinforcing capability, fine Carbon Blacks, tire tread blacks (primary particle size: 1 – 30 nm)

Soft Blacks:

Semi-reinforcing capability, carcass Carbon Blacks (primary particle size: 31 – 200 nm)

Thermal Blacks:

Minor reinforcing capability, high filling rates (primary particle size: >200 nm)

Today a classification according to ASTM D 1765 is widely used.

The first character in the nomenclature system for Rubber Carbon Blacks indicates the effect of the Carbon Black on the cure rate of a typical rubber compound containing the Carbon Black. The letter “N” is used to indicate a normal curing rate of typical Furnace Blacks that have received no special modification to alter their influence on the curing rate of rubber. The letter “S” is used for Channel Blacks or for Furnace Blacks that have been usually modified by oxydative methods, to

effectively reduce the curing rate of rubber. Channel Blacks characteristically impart a slower curing rate to rubber compounds. Thus, the letter “S” designates a slow cure rate. Carbon Blacks may vary considerably in curing rate within each of the two letter classifications.

A 3-digit number follows the first character in the nomenclature system. The first digit designates the average surface area of the Carbon Black as measured by nitrogen surface area. The surface area range of Carbon Black has been divided into 6 arbitrary groups. Each has been assigned a digit to describe that group (Table 8). The digits 2 and 3 have no connotative meaning.

The N300 series is characterized by a wide variety of Rubber Carbon Blacks, covering no fewer than 10 different types. As mentioned above, fine-particle Carbon Blacks are used for rubber components that need to withstand significant levels of mechanical stress, e.g. tire treads.

Soft blacks, on the other hand, are used in the tire carcass but also in technical rubber components, from windscreen seals to door seals and floor mats. More than 90 % of the world’s Carbon Black output is used in the rubber industry, hence the dominant role of Rubber Carbon Blacks.

Rubber Carbon Blacks

Designation	Nitrogen Surface Area (m ² /g)
N100	121 – 150
N200	100 – 120
N300	70 – 99
N500	40 – 49
N600	33 – 39
N700	21 – 32
N900	< 10

Table 8:
ASTM Rubber Carbon Black typology (excerpt)



6 Applications

6.2 Specialty Carbon Blacks

Specialty Carbon Blacks have a number of advantages compared to black organic dyes:

- Color stability
- Solvent resistance
- Acid and alkaline resistance
- Thermal stability
- High hiding power

These Carbon Blacks are used for a variety of applications in the printing, paints, coatings, plastics, fiber, paper and construction industries. Here also the industry works with a widely accepted typology based on particle size. Although not considered an international standard, it serves as the main reference for most manufacturers.

The classification system identifies four groups: High Color (HC), Medium Color (MC), Regular Color (RC) and Low Color (LC). The third letter refers to the manufacturing process: (F) for Furnace Black and (G) for Channel or Gas Black. Treatment is indicated by the suffix (o).

New Specialty Carbon Blacks developed on an ongoing basis, are sustaining and driving the pace of innovation in the area of non-impact printing methods. Today, the Specialty Carbon Black manufactured according to the Degussa Gas Black method is at the forefront of the industry.

Specialty Carbon Blacks

Designation		Range of Median Primary Particle Size* (nm)
Gas Blacks	Furnace Blacks	
HCG	HCF	10 – 15
MCG	MCF	16 – 24
RCG	RCF	25 – 35
	LCF	> 36
Gas Blacks (treated)		
HCG (o)		10 – 17
MCG (o)		18 – 24
RCG (o)		> 25

Table 9:
Specialty Carbon Black classification

In the coatings sector, treated, fine particle Carbon Blacks are the key to deep jet black paints. On the other hand, coarse Carbon Blacks, the so-called tinting blacks, are indispensable for obtaining a desired grey shade or color hue.

Carbon Black applications abound in the plastics industry. As in the coatings industry, fine-particle types are used for obtaining a deep jet black color. Its ability to absorb detrimental UV light and convert it into heat, makes plastics such as polyolefines, and especially polyethylene, more resistant to UV radiation. Anti-static treatment is also an important application area, as the related field of compounds for power cables. The plastics sector also covers the black pigmentation of synthetic fibers.

The paper industry uses Carbon Blacks with medium-sized particles mainly for decorative and photo-protective products. Relatively coarse particles characterize the Carbon Blacks utilized in the construction industry.

Other special application areas, though not focused on the pigmentation properties of these Carbon Blacks, are also included here e.g., the production of carbon brushes and electrodes, as well as metal, metal oxide reduction and molten metal covering systems. All of these are most suitable for Lamp Blacks.

Though the list of applications is far from being exhausted, the uses described here give a good idea of the impact of Carbon Black in the world around us.

Carbon Black is one of the basic substances that is indispensable to industry and technology. It comes in many varieties, each tailored to applications in the most diverse areas. Indeed, Carbon Black has come a long way and who would have thought that Carbon Black would have such a bright future?

Without Carbon Black...

... the tires on your car would not provide that extra measure of durability and safety.

... your morning newspaper would never make it to the breakfast table on time.

... photocopiers might still be mimeograph machines.

... books would simply fade away.

... fashion would miss out on the elegance of a touch of black.

... grand pianos would only come in lighter shades.

... stretch limos would all be white.

... your car would miss the sealings which protect you from getting wet inside.

... there would be no anti-vibration measures and car rides could be quite bumpy.

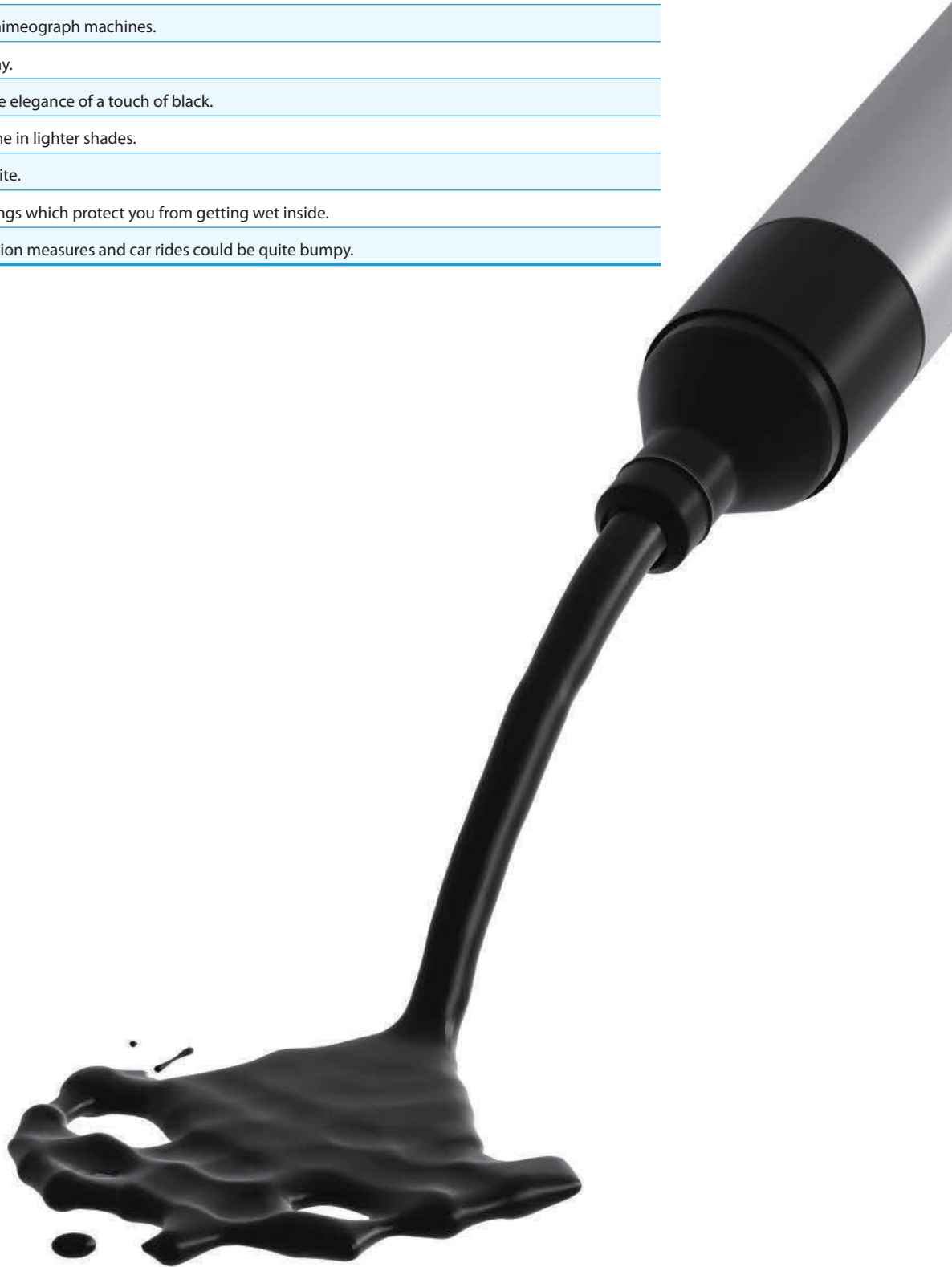

6 Applications



ORION ENGINEERED CARBONS
Focused. Innovative. Responsive.





The Americas

Orion Engineered Carbons LLC
1700 City Plaza Drive, Suite 300
Spring, TX 77389
USA
Phone +1 832 445 3300

AMERICAS@orioncarbons.com

Europe/ Middle East/ Africa

Orion Engineered Carbons GmbH
Hahnstraße 49
60528 Frankfurt am Main
Germany
Phone +49 69 36 50 54 100

EMEA@orioncarbons.com

Asia Pacific

Orion Engineered Carbons (China) Investment Co., Ltd.
Room 3701-3702, BM InterContinental Business Center,
100 Yutong Road
Shanghai 200070, P. R. China
Phone +86 21 61 07 09 66

APAC@orioncarbons.com

Global Corporate Headquarters

Orion Engineered Carbons S.A., 6 Route de Trèves, L-2633 Senningerberg, Luxembourg, Phone +352 27 04 80 60

www.orioncarbons.com

All statements given by Orion Engineered Carbons GmbH as well as its affiliates, including for example Orion Engineered Carbons S.A. ("Orion") herein are provided for information purposes only and are given as of the date of this document and are based on the knowledge on the date of the document. ORION DOES NOT GIVE ANY REPRESENTATION OR WARRANTY THAT THE CONTENTS OF THE GIVEN STATEMENTS AND INFORMATION ARE CORRECT OR ACCURATE. ANY LIABILITY OF ORION WITH REGARD TO THE CONTENTS PROVIDED ARE HEREBY EXPRESSLY EXCLUDED. Orion does not give a warranty with respect to any results to be obtained from such information, any uses of such information or with regard to the non-infringement of any proprietary right. Nothing stated herein shall be construed as a license of or recommendation for use, especially with concern to the potential infringement of any proprietary right. Use or application of such information or statements or the material or systems described herein are at user's sole discretion and risk. The user acknowledges that Orion shall bear no responsibility or liability for any use or application of such information or statements or the material or systems described herein. All sales are subject to the respective standard terms and conditions of Sale issued by Orion including but not limited to the limitation of liability contained therein. The Orion standard terms and conditions of Sale can be reviewed, downloaded and printed under https://orioncarbons.com/en/general_conditions_of_sale_and_delivery_orion_engineered_carbons_europe_africa.pdf. Any and all information disclosed by Orion herein shall remain the property of Orion.

© 2021 Orion Engineered Carbons GmbH

OEC-03/2021